

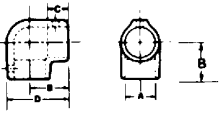









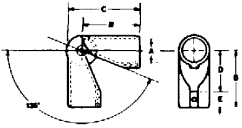

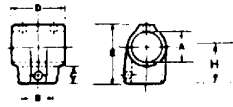

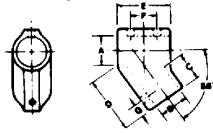
SPEED-RAIL® SLIP-ON IN-LINE FITTINGS

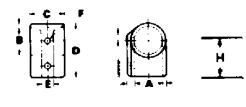

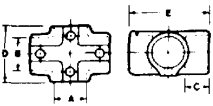
		I.P.S. SIZE	A	B	C	D	E	F	G	H	
		1/2"	0.85	1 1/16	1	2 1/8					
		3/4"	1.07	1 1/2	1	2 1 3/32					
		1"	1.34	1 3/4	1 1/8	2 3/8					
		1 1/4"	1.68	2	1 3/16	3 3/16					
		1 1/2"	1.93	2 5/16	1 3/8	3 3/4					
2"	2.40	3	1 3/4	4 3/8							
		1 1/4"	1.68	3 3/8	4 3/8	2 3/8	1 1/2				
		1/2"	0.85	0.85	3/8	1 1 1/16	2 3/8			1 1/16	
		3/4"	1.07	1.07	3/8	1 2 3/32					1 1/2
		1"	1.34	1.34	1	2 3/8	2 2 7/32				1 3/4
		1 1/4"	1.68	1.68	1	2 3/4	3 3/32				2
		1 1/2"	1.93	1.93	1 3/16	3 3/8	3 2 3/32				2 5/16
2"	2.40	2.40	1 3/8	3 3/8	4 5/8				3		
		1/2"	0.85	0.85	1	1 1 1/16	1 1 1/16				
		3/4"	1.07	1.07	1	2	2	1	7/16		
		1"	1.34	1.34	1 1/8	2 5/16	2 3/8	1 1/4	3/16		
		1 1/4"	1.68	1.68	1 1/8	2 5/16	2 3/4	1 1/2	9/16		
		3/4"	1.07	1.07	1 1/2	2 1/4	1/2	5/16-18		1 1/2	
		1"	1.34	1.34	1 3/4	2 3/8	9/16	3/8-16		1 3/4	
		1 1/4"	1.68	1.68	2	3	5/8	3/8-16		2	
		1 1/2"	1.93	1.93	2 5/16	3 3/8	5/8	3/8-16		2 1/2	
		1/2"	0.85	0.85	1	1 1 1/16	2 2 7/32				
		3/4"	1.07	1.07	1 5/16	2	3				
		1"	1.34	1.34	1 1/8	2 3/8	3 3/16				
		1 1/4"	1.68	1.68	1 1/8	2 3/4	4				
		1 1/2"	1.93	1.93	1 5/16	3 3/8	4 3/8				
2"	2.40	2.40	2 3/4	3 3/8	6						
		3/4"	1.07	1.07	1 1/2	3	1/2	5/16-18			
		1"	1.34	1.34	1 3/4	3 1/2	9/16	3/8-16			
		1 1/4"	1.68	1.68	2	4	5/8	3/8-16			
		1 1/2"	1.93	1.93	2 5/16	4 1/16	5/8	3/8-16			
		1/2"	0.85	0.85	2 1/32	1 9/32	2 1/8	1 1/16		1 1/16	
		3/4"	1.07	1.07	2 7/32	2 3/32	2 1 1/32	2 7/32		1 1/2	
		1"	1.34	1.34	2 1 1/16	2 9/32	2 1 3/16	1 1/32		1 3/4	
		1 1/4"	1.68	1.68	3	1 1/16	3 3/4	1 3/32		2	
		1 1/2"	1.93	1.93	3 3/16	1 3/16	3 2 3/32	1 3/8		2 5/16	
2"	2.40	2.40	4 7/16	1 1 1/16	4 3/4	1 5/8		3			

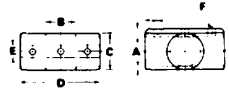
NO. 11 SIDE-OUTLET TEE

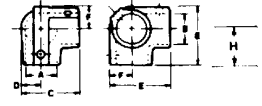
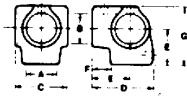

I.P.S. SIZE	A	B	C	D	E	F	G	H
1/2"	0.85	0.85	1 1/16	2 1/8	1 1/16	3 1/32	2 3/32	
3/4"	1.07	1.07	2	2 3/8	1 1/2	3 1/32	2 11/32	
1"	1.34	1.34	2 3/8	2 27/32	1 3/4	1 1/8	2 27/32	
1 1/4"	1.68	1.68	2 3/4	3 3/32	2	1 1/8	3 1/4	
1 1/2"	1.93	1.93	3 1/4	3 13/16	2 5/16	1 3/8	3 13/16	
2"	2.40	2.40	3 3/8	4 1/16	3	1 13/16	4 5/8	

NO. 11E SIDE-OUTLET TEE

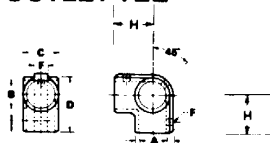

3/4"	1.07	1.07	1 1/2	2.26	1/2	5/16-18		1 1/2
1"	1.34	1.34	1 3/4	2.63	9/16	3/8-16		1 3/4
1 1/4"	1.68	1.68	2	3.03	5/8	3/8-16		2
1 1/2"	1.93	1.93	2 5/16	3.36	3/4	3/8-16		2 5/16

NO. 13 SIDE-OUTLET CROSS

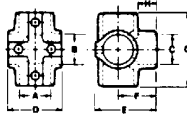

1/2"	0.85	0.85	0.85	1 1/16	2 1/8	1 1/16	2 27/32	
3/4"	1.07	1.07	1.07	2	2 1/16	1 1/2	3	1 5/16
1"	1.34	1.34	1.34	2 3/8	2 13/16	1 25/32	3 9/16	1
1 1/4"	1.68	1.68	1.68	2 3/4	3 3/32	2	4	1 1/16
1 1/2"	1.93	1.93	1.93	3 3/8	3 33/32	2 5/16	4 5/8	1 1/4

NO. 17 ADJ. ELL OR TEE

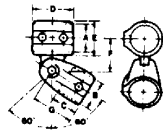

1/2"	0.85	0.85	1 5/16	1 11/16	1 3/16	1 1/4	1 1/2	
3/4"	1.07	1.07	1 5/16	2	1 1/16	1 1/16	1 11/16	
1"	1.34	1.34	1 1/8	2	1 1/8	1 1/8	2	
1 1/4"	1.68	1.68	1 7/16	2 3/8	2 1/8	2 1/16	2 9/16	
1 1/2"	1.93	1.93	1 3/4	2 3/4	2 3/8	2 3/16	2 3/4	

NO. 19 ADJ. CROSS

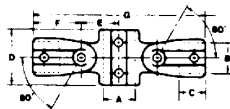

3/4"	1.07	1.07	1 5/16	2	1 5/16	1 15/16	6 1/2	
1"	1.34	1.34	1 1/8	2 3/8	1 5/8	2	7 1/4	
1 1/4"	1.68	1.68	1 7/16	2 3/4	1 15/16	2 9/16	9	
1 1/2"	1.93	1.93	1 3/4	3 3/8	2 1/4	2 3/4	10	

NO. 21-35° ADJ. CROSS (10° TO 35°)

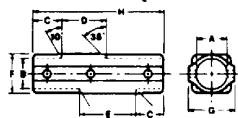

3/4"	1.07	1.07	3/8	1 5/16	1 1/8	1 13/32	1 11/16	4
1"	1.34	1.34	1 1/8	1 21/32	2 3/8	1 3/4	2 33/32	4 13/16
1 1/4"	1.68	1.68	1 1/8	2 1/16	2 15/16	2 5/32	2 7/16	5 1/2
1 1/2"	1.93	1.93	1 11/32	2 3/8	3 1/16	2 3/8	2 13/16	6 3/8

NO. 21-45° ADJ. CROSS (30° TO 45°)

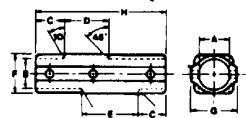

3/4"	1.07	1.07	3/8	1 1/2	1 5/16	1 13/32	1 11/16	4 1/2
1"	1.34	1.34	1	1 29/32	2 5/16	1 3/4	2 33/32	5 1/2
1 1/4"	1.68	1.68	1 1/16	2 3/8	3	2 5/32	2 7/16	6 3/8
1 1/2"	1.93	1.93	1 3/16	2 11/16	9 9/16	2 3/8	2 13/16	7 1/4

NO. 23 ADJ. TEE OR CROSS

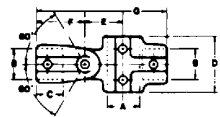

3/4"	1.07	1.07	1 5/16	2	1 11/16	1 5/16	4 3/4	
1"	1.34	1.34	1 1/8	2 3/8	1 11/32	2	5 5/16	
1 1/4"	1.68	1.68	1 7/16	2 3/4	1 15/16	2 9/16	6 1/2	
1 1/2"	1.93	1.93	1 3/4	3 3/8	2 1/4	2 3/4	7 5/16	

NO. 25 ADJ. SIDE-OUTLET ELL OR TEE

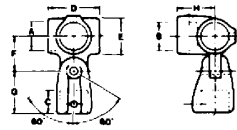

3/4"	1.07	1.07	1 1/16	2	1 1/16	1 1/16	1 1 1/16	1 1/2
1"	1.34	1.34	1 1/8	2 3/8	1 1/8	1 1/8	2	1 2 1/2
1 1/4"	1.68	1.68	1 1/4	2 1/2	2 1/8	1 1 1/16	2 1/8	2
1 1/2"	1.93	1.93	1 1/2	3	2 1/4	2 1/4	2 1/4	2 1/2

NO. 27 DBL. ADJ. SIDE-OUTLET ELL OR TEE

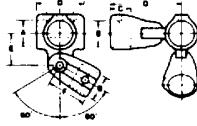

3/4"	1.07	1.07	1 1/16	2	1 1/16	1 1 1/16	3/4
1"	1.34	1.34	1 1/8	2 3/8	1 1/8	2 1/8	3/8
1 1/4"	1.68	1.68	1 1/4	2 1/2	1 1 1/16	2 1/8	4 1/2
1 1/2"	1.93	1.93	1 1/2	3	2 1/4	2 1/4	5

NU-RAIL® SLIP-ON OFFSET FITTINGS

NO. 10 CROSS

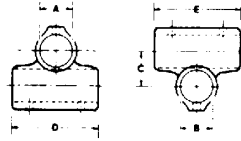

I.P.S. SIZE	A	B	C	D	E	F	G
<i>Straight Sizes</i>							
3/4"	1.07	1.07	1 3/16	2 1/2	2 1/2		
1"	1.34	1.34	1 1/8	3 1/2	3 1/2		
1 1/4"	1.68	1.68	1 1 3/16	3 1/2	3 1/2		
1 1/2"	1.93	1.93	2	3 1/2	3 1/2		
2"	2.40	2.40	2 1/2	4	4		
<i>Reducing Sizes</i>							
1"x3/4"	1.34	1.07	1 1/16	2 1/2	3		
1 1/4"x1"	1.68	1.34	1 1/8	3 1/2	3 1/2		
1 1/2"x1 1/4"	1.93	1.68	1 2 9/32	3 1/2	3 1/2		
2"x1 1/2"	2.40	1.93	2 9/32	3 1/2	4		

NO. 12 SHORT BARREL CROSS

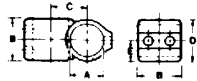

3/4"	1.07	1 1/2	1 3/16	1 1 9/32	2 3/32		
1"	1.34	1 1/8	1 1/8	1 2 5/32	2 9/32		
1 1/4"	1.68	2 1/4	1 1 3/16	2 5/32	1 1/8		
1 1/2"	1.93	2 1/2	2 1/32	2 1/8	1 1/4		

(3/4" size has one setscrew in each barrel)

NO. 15 OFFSET TEE

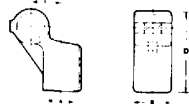

1 1/4"	1.68	2 1/4	1 1 3/16	5 1/8
--------	------	-------	----------	-------

NO. 20 OUTSIDE CORNER

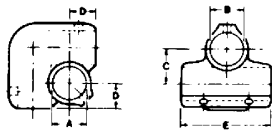

<i>Straight Sizes</i>							
3/4"	1.07	1.07	1 1/16	3/4	2 1/2		
1"	1.34	1.34	1 1/8	1	3 1/2		
1 1/4"	1.68	1.68	1 1 3/16	1 3/16	3 1/2		
1 1/2"	1.93	1.93	2	1 3/8	3 1/2		
2"	2.40	2.40	2 1/2	1 9/16	4		
<i>Reducing Sizes</i>							
1"x3/4"	1.34	1.07	1 1/16	7/8	3		
1 1/4"x1"	1.68	1.34	1 3 7/64	1 3/16	3 1/2		
1 1/2"x1 1/4"	1.93	1.68	1 1/8	1 3/8	3 1/2		
2"x1 1/2"	2.40	1.93	2 2 9/32	1 1/8	4		

NO. 30 ADJ. CROSS

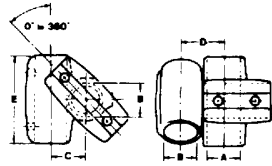

I.P.S. SIZE	A	B	C	D	E	F	G
3/4"	1.07	1.07	1 1/16	1 3/8	2 1/2		
1"	1.34	1.34	1 1/8	1 2 1/32	3 1/2		
1 1/4"	1.68	1.68	1 3/16	2	3 1/2		
1 1/2"	1.93	1.93	2	2 1/4	3 1/2		
2"	2.40	2.40	2 1/2	2 13/16	4		
<i>Reducing Sizes</i>							
1" x 3/4"	1.34	1.07	1 9/32	1 1/16	3		
1 1/4" x 1"	1.68	1.34	1 7/64	1 53/64	3 1/2		
1 1/2" x 1 1/4"	1.93	1.68	1 1/8	2 1/8	3 1/2		
2" x 1 1/2"	2.40	1.93	2 15/64	2 31/64	4		

NO. 30-A MODIFIED CROSS

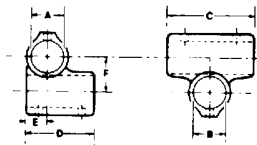

I.P.S. SIZE	A	B	C	D	E	F	G
3/4"	1.07	1.07	2 1/2	2 1/4	1 1/16	1 3/16	
1"	1.34	1.34	3 1/2	2 3/4	2 7/32	1 1/16	
1 1/4"	1.68	1.68	3 1/2	2 3/4	1	1 13/16	
1 1/2"	1.93	1.93	3 1/2	3 1/8	1 1/8	2 1/32	
2"	2.40	2.40	4	3 5/16	1 1/16	2 1/2	
<i>Reducing Sizes</i>							
1" x 3/4"	1.34	1.07	3	2 1/4	2 7/64	1 5/16	
1 1/4" x 1"	1.68	1.34	3 1/2	2 3/4	1	1 1/8	
1 1/2" x 1 1/4"	1.93	1.68	3 1/2	2 3/4	1 1/8	1 1/8	
2" x 1 1/2"	2.40	1.93	4	3 3/8	1 1/8	2 1/4	

NO. 30-B SWIVEL

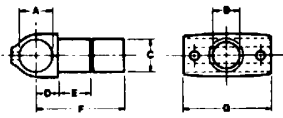

I.P.S. SIZE	A	B	C	D	E	F	G
3/4"	1.07	0.82	1.05	1 1/16	1 1/8	2 1/8	2 1/2
1"	1.34	0.96	1.32	2 7/32	1 3/8	3 1 7/32	3 1/2
1 1/4"	1.68	1.38	1.66	1	1 3/8	3 1 1/16	3 1/2
1 1/2"	1.93	1.61	1.90	1 1/8	1 9/16	4 3/16	3 1/2
2"	2.40	2.07	2.38	1 1/8	1 11/16	4 3/8	4

NO. 30-C ADJ. SWIVEL

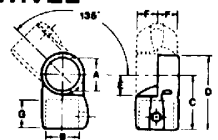

I.P.S. SIZE	A	B	C	D	E	F	G
3/4"	1.07	1.07	1 1/8	2 9/16	7/8	1 1/16	1
1"	1.34	1.34	2 5/16	3 5/16	1 1/16	2 7/32	1 1/4
1 1/4"	1.68	1.68	2 25/32	3 3/8	1 9/32	1 1/16	1 1/16
1 1/2"	1.93	1.93	3 1/8	4 3/8	1 1/2	1 1/32	1 5/8
2"	2.40	2.40	3 1/2	4 31/32	1 17/32	1 3/8	1 3/4

*END CAPS NOT INCLUDED

NU-RAIL® SLIP-ON FITTING COMBINATIONS



NO. 10



EII



Tee



Cross



NO. 20



Side-Outlet EII



Side-Outlet Tee



**NO. 30
COMBINATION**
1-NO. 30-A
1-NO. 30-B



Adjustable Ell



Adjustable Tee



Adjustable Cross



Side-Outlet
Adjustable Ell



Side-Outlet
Adjustable Tee



Side-Outlet
Adjustable Cross



COMBINATION
1-NO. 10
2-NO. 30-B



Double
Adjustable Ell



Double
Adjustable Tee



Double
Adjustable Cross



COMBINATION
1-NO. 30-A
1-NO. 30-C



Adjustable
Stair Landing
Tee



Side-Outlet
Adjustable
Stair Landing Tee



Double Side-Outlet
Adjustable
Stair Landing Tee



Adjustable
Stair Landing
Cross



Side-Outlet
Adjustable
Stair Landing
Cross











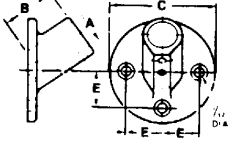

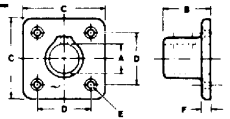

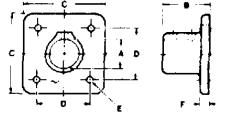

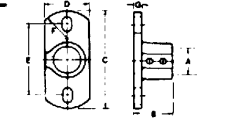
Double Side-Outlet
Adjustable
Stair Landing
Cross

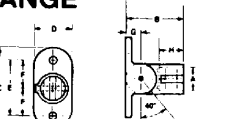
*END CAPS NOT INCLUDED

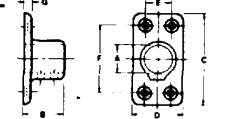
FLANGES, PLUGS, COUPLINGS AND BRACKETS

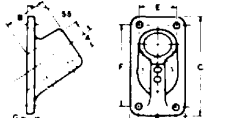
		I.P.S. SIZE	A	B	C	D	E	F	G	H
 	NO. 40 FLANGE	3/4"	1.07	1 1/2	2 1/2	2 1/4	1 1/4	1 1/2	3/8	
		1"	1.34	1 3/4	3 3/16	2 3/8	2 3/16	1 3/8	1/4	
		1 1/4"	1.68	1 3/4	3 3/8	3 1/2	2 3/8	2 1/4	1/4	
		1 1/2"	1.93	2 1/2	4 3/16	3 1 3/16	2 1 5/16	2 3/8	5/16	
		2"	2.40	2 1/2	5 1/16	4 1/2	3 1 3/16	3 1/4	5/16	
 	NO. 41 ADJ. FLANGE	1/2"	0.85	1 5/16	1 1/2	1 1/8	2 1/8	3		
	(Wall Mount ONLY)	3/4"	1.07	1 3/16	1 1 5/16	1 3/16	1 1/8	2 3/8	1 5/16	1 5/32
		1"	1.34	1 1/8	2	1 3/16	1 1/8	2 3/8	1 5/16	1 5/32
		1 1/4"	1.68	1 1 5/16	2 9/16	1 3/8	2 1/16	3 3/8	1 3/8	1 9/32
		1 1/2"	1.93	1 1/8	2 3/4	1 3/8	2 1/16	3 3/8	1 3/8	1 9/32
 	NO. 42 FLANGE	1/2"	0.85	1 1/8	3		2 1/8			
 	NO. 43 FLANGE	3/4"	1.07	1 3/4	2 1/2	1/4				
		1"	1.34	2 1/8	3	5/16				
		1 1/4"	1.68	2 7/16	3 1/2	5/16				
		1 1/2"	1.93	2 9/16	3 3/4	5/16				

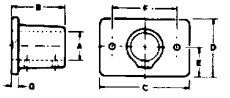
		I.P.S. SIZE	A	B	C	D	E	F	G	H
NO. 44—AF 55° FLANGE										
		½"	0.85	1⅝	3		1¼			
NO. 45 FLANGE										
		¾"	1.07	1½	2⅝	1¼	⅝	¼		
		1"	1.34	1⅜	3	2¼	⅝	¼		
		1¼"	1.68	2⅜	3⅜	2⅝	⅞	⅝		
		1½"	1.93	2⅜	3⅝	2⅝	⅞	⅝		
NO. 45SBC FLANGE										
		1½"	1.93	2½	5	3½	⅞	⅝		
NO. 46 FLANGE										
		1¼"	1.68	2⅜	5¼	2½	4¼	1¼	⅝	
		1½"	1.93	2⅜	5¼	2½	4¼	1¼	⅝	
NO. 46 ADJ. FLANGE										
		1½"	1.93	4¼	6½	2⅝	4½	2¼	1¼	1⅜
NO. 47 FLANGE										
		¾"	1.07	1½	3½	1⅝	(2 on CL) 2⅝	¼		
		1"	1.34	1⅜	3½	2⅝	1⅞	2⅝	⅝	
		1¼"	1.68	2⅜	4⅞	2⅜	1⅞	3	⅝	
		1½"	1.93	2⅜	4⅞	3⅝	2⅞	3¼	⅝	
		2"	2.40	2⅝	5	3¼	2⅞	3¼	⅝	
NO. 47—AF 55° FLANGE										
		¾"	1.07	1½	3½	1⅝	1⅞	2⅜	¼	
		1"	1.34	1⅜	3½	2⅝	1⅞	2⅜	¼	
		1¼"	1.68	2⅜	4⅞	2⅜	1⅞	3⅞	¼	
NO. 48 FLANGE										
		1½"	1.93	3½	6	4	2	4⅞	⅝	

FLANGES, PLUGS, COUPLINGS AND BRACKETS CONT.

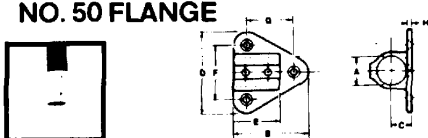
		I.P.S. SIZE	A	B	C	D	E	F	G	H	
	NO. 50 FLANGE		3/4"	1.07	3/4	1	3 3/16	2	2 1/4	2 1/4	3/16
			1"	1.34	3 3/8	1 1/16	3 3/8	2 1/4	2 1/2	2 5/8	1/4
			1 1/4"	1.68	3 7/8	1 1/32	4 3/16	2 1/2	3	2 5/8	5/16
			1 1/2"	1.93	4 1/2	1 3/8	4 7/16	3	3 3/4	3 1/16	3/8
			2"	2.40	4 7/8	1 9/32	5	3 3/8	3 3/4	3 3/8	5/16

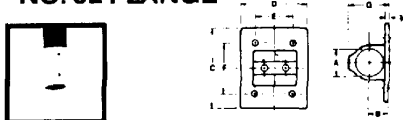
	NO. 52 FLANGE		1 1/4"	1.68	1 1/32	5 1/2	4	2 1/2	4	2 2 1/32
			1 1/2"	1.93	1 1/32	5 1/2	4 1/2	2 1/2	3 1/2	2 7/8

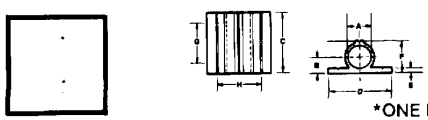
	NO. 52E FLANGE**		1 1/4"	1.67	1 1/32	5	5	3/8	2 5/16	3 1/2	3 1/2
			1 1/2"	1.93	1 1/32	5	5	3/8	2 2 1/32	3 1/2	3 1/2

*ONE HOLE EACH SIDE 9/16" FOR 1/2" ANCHOR TWO HOLES EACH SIDE 7/16" FOR 3/8" ANCHOR

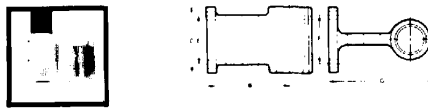
	NO. 54-3-4-5 FLANGE		1.93	3	4	4	3	3	4 3/8
				4					5 3/8
			1 1/2"		5				6 3/8

("B" Dimension is mounting surface to CL of barrel.)
Bracket Bolt Hole size is 1/2" diameter.

	NO. 60 PLUG		1/2"	0.63	1 1/16						
			3/4"	0.83	1 1/4						
			1"	1.06	1 5/8						
			1 1/4"	1.39	1 15/16						
			1 1/2"	1.62	2 3/16						

("B" Dimension matches O.D. of Fitting, not Pipe.)

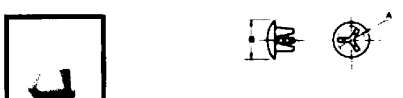
	NO. 62 PLUG		3/4"	0.83	1.05						
			1"	1.06	1.32						
			1 1/4"	1.39	1.66						
			1 1/2"	1.62	1.90						

("B" Dimension matches O.D. of Pipe, not Fitting.)

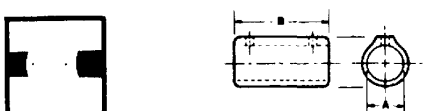
	NO. 70 COUPLING		3/4"	1.07	2 1/2						
			1"	1.34	3 1/2						
			1 1/4"	1.68	3 3/4						
			1 1/2"	1.93	3 1/2						
			2"	2.40	4						

NO. 82 HANDRAIL BRACKET

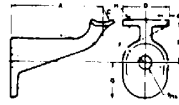

I.P.S. SIZE	A	B	C	D	E	F	G	H
1 1/4"	4 1/8"	1 27/32	2	2 1/8	5/16	1 1/16	1 1/8	3/16
(Fits 1 1/4" & 1 1/2" Handrail)								

NO. 82A HANDRAIL BRACKET

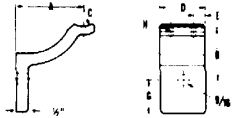

1 1/4"	3"	3 1/8	7/8	2	3/8	—	1 1/2	3/16
(Fits 1 1/4" & 1 1/2" Handrail)								

NO. 82E HANDRAIL BRACKET**

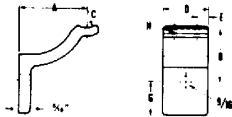

1 1/4"	3"	3 1/8	7/8	2	3/8	—	1 1/2	3/16
(Fits 1 1/4" & 1 1/2" Handrail)								

NO. 84 L OR R HANDRAIL BRACKET

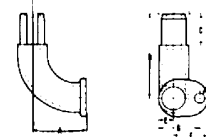

1 1/4"	4 1/8	1.67	1 1/4	4 3/4	1 3/16	1 1/8	2 1/16	9/16
(Fits 1 1/4" Handrail Only)								
Made in R.H. or L.H. When ordering, please specify.								

NO. 84A L OR R HANDRAIL BRACKET

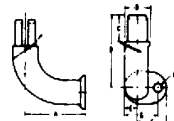

1 1/4"	3"	1.67	1 1/4	4 3/4	1 3/16	1 1/8	2 1/8	9/16
(Fits 1 1/4" Handrail Only)								
Made in R.H. or L.H. When ordering, please specify.								

WALL-MOUNTED HANDRAIL FITTINGS

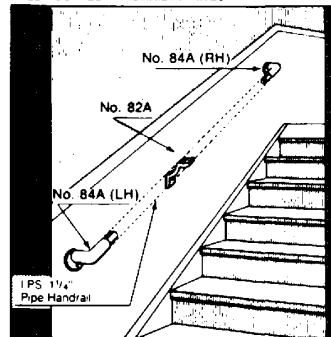

TOE-BOARD FLANGE & BRACKET FITTINGS

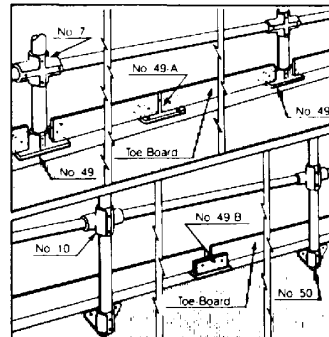

LOAD CAPACITY OF STD. I.P.S. SIZE STEEL PIPE — SCHEDULE 40 25,000 P.S.I. LOW-CARBON STEEL

SIMPLE BEAM CONSTRUCTION

(Yield Stress 25,000 PSI with two beams supporting a uniformly distributed load.)

Beam Length

Pipe Size	2'	3'	4'	5'	6'	8'	10'
¾" Sch. 40 I.P.S.	900	600	451	361	301	226	180
1" Sch. 40 I.P.S.	1700	1136	848	680	567	424	340
1¼" Sch. 40 I.P.S.	3007	2000	1503	1200	1002	751	600
1½" Sch. 40 I.P.S.	4182	3184	2091	1672	1592	1045	835
2" Sch. 40 I.P.S.	7187	4800	3600	2874	2400	1800	1437

Note 1: Safety factor of 1.3 to 1 is provided.

Note 2: The addition of a third beam of the same length and diameter will increase load capacity of the span by 35% of stated capacity.

SIMPLE BEAM CONSTRUCTION

(Yield Stress 25,000 PSI with two beams supporting a load concentrated at the center of the clear span.)

Beam Length

Pipe Size	2'	3'	4'	5'	6'	7'	8'
¾" Sch. 40 I.P.S.	450	300	225	180	Not Recommended		
1" Sch. 40 I.P.S.	850	568	424	340	284	Not Recommended	
1¼" Sch. 40 I.P.S.	1503	1000	752	600	501	429	376
1½" Sch. 40 I.P.S.	2090	1592	1045	836	796	597	522
2" Sch. 40 I.P.S.	3593	2400	1800	1437	1200	1026	900

Note: Safety factor of 1.3 to 1 is provided.

COLUMN LOAD CAPACITY

(Yield Stress 25,000 PSI, Working Stress 12,500 lbs.)

Column Height

Pipe Size	1'	2'	3'	4'	5'	6'	8'
¾" Sch. 40 I.P.S.	4000	3250	2250	Not Recommended			
1" Sch. 40 I.P.S.	6000	5250	4250	3000	Not Recommended		
1¼" Sch. 40 I.P.S.	8250	7500	7000	5750	4250	Not Recommended	
1½" Sch. 40 I.P.S.	9750	9500	8750	7500	6250	4750	Not
2" Sch. 40 I.P.S.	13,250	12,500	12,000	11,250	10,250	9000	Rec.

Note 1: Values shown are for EACH COLUMN in the structure.

Note 2: A column is deemed to exist from the floor line to the first horizontal load bed, or between any two load beds attached to the columns.

Example: A rack 4' high with load beds at 2' and 4' from floor, is made up of eight 2' columns even though overall length of each upright = 4'.

CANTILEVER CONSTRUCTION

(Yield Stress 25,000 PSI for two cantilever arms supporting a uniformly distributed load.)

Cantilever Length

Pipe Size	1'	2'	3'	4'	5'
¾" Sch. 40 I.P.S.	450	226	150	113	90
1" Sch. 40 I.P.S.	850	426	284	212	170
1¼" Sch. 40 I.P.S.	1503	752	500	376	300
1½" Sch. 40 I.P.S.	2090	1045	796	522	418
2" Sch. 40 I.P.S.	3593	1796	1200	900	718

Note: Safety factor of 1.3 to 1 is provided.

CANTILEVER CONSTRUCTION

(Yield Stress 25,000 PSI for two cantilever arms supporting a concentrated load at varying distances from the vertical support column.)

Cantilever Length

Pipe Size	1'	2'	3'	4'	5'
¾" Sch. 40 I.P.S.	225	113	75	Not Recommended	
1" Sch. 40 I.P.S.	425	213	142	106	85
1¼" Sch. 40 I.P.S.	752	376	250	188	150
1½" Sch. 40 I.P.S.	1045	523	348	261	209
2" Sch. 40 I.P.S.	1797	898	599	449	359

Note: Safety factor of 1.3 to 1 is provided.

LOAD CAPACITIES OF FITTINGS SETSCREWS WHEN PROPERLY TORQUED

Fitting Size	Torque Ft. Lbs.	No. Screws	Load Capacity
¾"	12.5 lbs.	2	1900 lbs.
¾"	12.5 lbs.	1	1000 lbs.
1"	14.2 lbs.	2	1800 lbs.
1"	14.2 lbs.	1	1200 lbs.
1¼"	16.7 lbs.	2	3100 lbs.
1¼"	16.7 lbs.	1	2300 lbs.
1½"	16.7 lbs.	2	2350 lbs.
2"	16.7 lbs.	2	3200 lbs.

Above data compiled by an independent laboratory using the following test procedures: Standard I.P.S.-sized pipe within the vertical barrel of the test fittings, to the torque shown above. A 30,000 lb. Universal Testing Machine applied vertical load to the pipe member in an attempt to produce pipe slippage. Load capacities listed above are based on a safety factor of 100%.

LOAD CAPACITIES OF STD. I.P.S. SIZE ALUMINUM PIPE SCH. 40 6063-T6

TYPICAL HANDRAIL SECTION

Pipe Size	Section	Deflection	Recovery To
1¼"	5'	2.125	.138
1¼"	10'	2.247	.489
1½"	8'	1.119	.129
1½"	16'	1.964	.747

Above data compiled by an independent laboratory using a 2000 lb. proving ring and at a side load of 200 lbs.

Aluminum pipe is not recommended for racking systems.

LOAD CAPACITIES OF FITTINGS SETSCREWS WHEN PROPERLY TORQUED

Fitting Size	Torque Ft. Lbs.	No. Screws	Load Capacity
1¼"	9.0	1	937 lbs.
1¼"	9.0	2	1006 lbs.
1½"	10.0	1	950 lbs.
1½"	10.0	2	1020 lbs.

Above data compiled by an independent laboratory using the following procedures. A 30,000 lb. universal testing machine applied vertical load to pipe member in an attempt to produce pipe slippage through the vertical barrel of the fitting. Load capacities listed above are based on a safety factor of 100%.

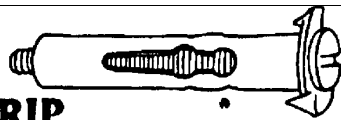

WALLGRIP HOLLOW WALL ANCHORS

Cat. No. 2700
SIZE RANGE: 1/8" Extra Short to 1/4" Extra Long

- ★ Greater holding power than nails or screws in hollow walls
- ★ Use in wallboard and paneling
- ★ Nut has more threads than similar anchors of other brands, for superior holding power
- ★ Securely fasten mirrors, pictures, etc.
- ★ Fixtures can be removed or replaced without disturbing the Wallgrip
- ★ Available with Hex Washer Slotted Screws for power driven installations
- ★ GSA: FF-B-588-C, Type III

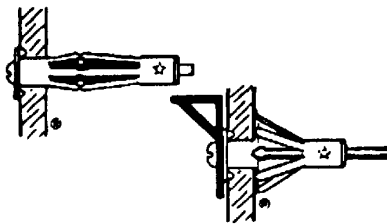

Drill hole. Tap Wallgrip into hole until prongs are embedded in wall. Turn screw until firm. Remove screw, place fixture and re-insert screw into Wallgrip and tighten.



DRIVE WALLGRIP HOLLOW WALL ANCHORS

Cat. No. 2800
SIZE RANGE: 1/8" Short and 1/8" Long

- ★ Easy and quick installation
- ★ Greater holding power than nails or screws in hollow walls
- ★ Use in wallboard, plaster and paneling
- ★ No predrilling required
- ★ Drives into wall in seconds
- ★ Saves labor
- ★ Securely fasten mirrors, pictures, etc.
- ★ Available with Hex Washer Slotted Screws for power-driven installations

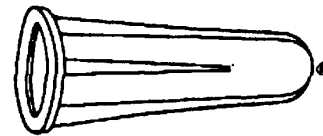

CONICAL PLASTIC ANCHORS

Cat. No. 600
SIZE RANGE: 6-8 x 3/4" to 14-16 x 1 1/4"

- ★ For hollow or solid wall, ceiling or floor applications
- ★ Unique Star formula makes our Plastic Anchor superior in extreme hot or cold environments
- ★ Quick and easy to use
- ★ Inexpensive installation
- ★ Available in kits with screws and masonry drill
- ★ Use with sheet metal screws or wood screws

PIN GRIPS

Cat. No. 2200
SIZE RANGE: 3/16" x 7/8" to 1/2" x 3 1/2"

- ★ Use in concrete, brick, stone or wood
- ★ No hole spotting
- ★ One piece construction
- ★ Quick and easy to install
- ★ Tamper proof
- ★ Light duty general purpose
- ★ GSA: FF-S-325, Group 5, Type 2, Class 2



Drill hole. Inscall Pin Grip through fixture and into drilled hole. Drive pin in with several light hammer blows until pin is flush with head of Pin Grip.

NAIL ANCHORS

Cat. No. 2600
SIZE RANGE: 3/16" x 7/8" to 1/4" x 2"

- ★ Use in concrete, block, brick or stone
- ★ No hole spotting
- ★ Fast and easy to use
- ★ One piece, pre-assembled construction
- ★ GSA: FF-S-325, Group 5, Type 2, Class 3

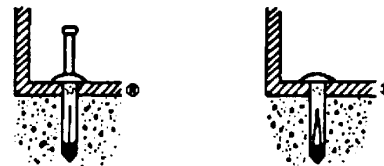

With fixture in place drill hole. Insert Nail Anchor. Hammer nail flush with head of anchor.

WEDGE ANCHORS

Cat. No. 3500
 SIZE RANGE: 1/4" x 1 3/8" to 1" x 12"

- ★ All steel construction for long-lasting performance
- ★ Ideal Anchor for use in concrete, brick, or stone
- ★ Pre-assembled anchor bolt is ready to use
- ★ No hole spotting
- ★ No need for exact hole depth
- ★ GSA: FF-S-325, Group 2, Type 4, Class 1

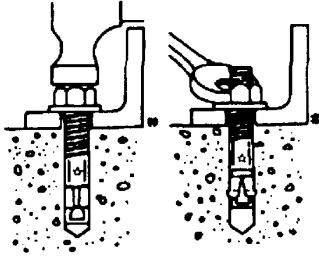

Drill hole in concrete. Drive wedge anchor into hole through fixture. Tighten nut until secure.

SLEEVE TYPE STUD BOLT ANCHORS

Cat. No. 3700
 SIZE RANGE: Diameters 1/4" - 3/4" / Lengths 3/4" - 6"

- ★ All steel construction for long-lasting performance
- ★ Use in concrete, block, brick, or stone
- ★ Preassembled anchor is ready to use
- ★ Removable after use
- ★ Hex nut, acorn nut, stud bolt, flat head available
- ★ No hole spotting
- ★ No special installation tools required
- ★ GSA: FF-S-325, Group 2, Type 3, Class 3

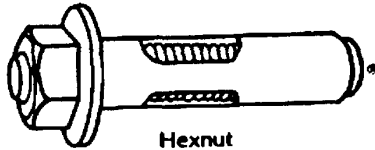

Hexnut

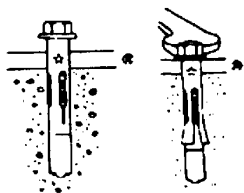

Drill hole in masonry through mounting holes in fixture. Insert anchor assembly and tighten nut.

STAZIN LAG SCREW EXPANSION SHIELDS

Cat. No. 1800
 SIZE RANGE: 1/4" short to 3/4" long

- ★ Use in concrete, mortar, or stone
- ★ Rustproof
- ★ Heavy external corrugations assure powerful gripping action
- ★ GSA: FF-S-325, Group 2, Type 1, Class 1 and 2



TAMPIN SCREW ANCHORS

Cat. No. 4000
 SIZE RANGE: 6-32 to 3/4"

- ★ Use in concrete, brick, or stone
- ★ Setting Tool provided free in each box of anchors
- ★ Fits into irregular holes
- ★ Available in open bottom and closed bottom
- ★ Sleeve expands into irregularities of hole
- ★ 3/8" - 3/4" U.L. Listed Pipe Hangers
- ★ GSA: FF-S-325, Group 2, Type 2, Class 1



NYLON ANCHORS

Cat. No. 2400
 SIZE RANGE: 1/16" x 3/4" to 1/4" x 2"

- ★ No hole spotting
- ★ Quick, easy and economical to use
- ★ Excellent thermal and insulating qualities
- ★ Resistant to chemicals and fungus
- ★ Can be used in hollow or solid applications
- ★ Available in round, round thin, flat, and truss heads
- ★ Available in Kits
- ★ GSA: FF-S-325, Group 5, Type 2, Class 4

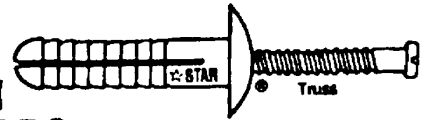

SOLID APPLICATION

HOLLOW APPLICATION

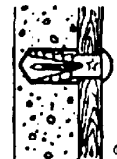

Drill hole. Insert Nylon Anchor through object to be fastened and drive expander pin flush with head of anchor.

SNAPIN SPRING WING TOGGLE BOLTS

Cat. No. 3000
SIZE RANGE: 1/4" x 2" to 1/2" x 6"

- * Use in hollow walls, hung ceilings and horizontal surfaces
- * Excellent holding power in hollow walls of all types including concrete block
- * Cast trunkon nut has more threads than toggle bolts of other brands, for superior holding power
- * Available in four head styles - round, flat, hex and mushroom

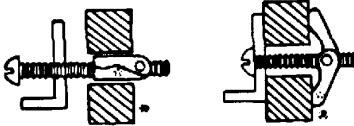

Drill hole. Insert bolt through item to be fastened. Attach wings. Fold wings and insert bolt through hole until wings spring open. Pull back to hold wings against inside wall and tighten screw.

PLASTIC TOGGLE SCREW ANCHORS

Cat. No. 3200

SIZE RANGE: Hollow walls of 1/8", 1/4", 3/8" thicknesses
All solid walls
All shallow walls

- * Fast and easy to use
- * Uses screw sizes from #8 to #12
- * Always works regardless of wall thickness or material
- * Requires one drill size - 3/16"

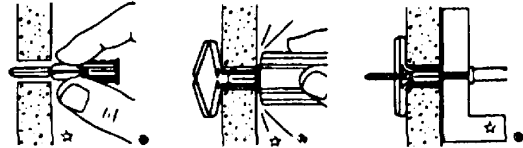

Drill 3/16" hole. Squeeze toggle wings flat and push into hole. Tap flush with wall. Place fixture, insert screw and tighten until secure.

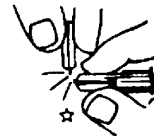

For shallow and solid wall or ceiling applications, squeeze toggle wings flat. Grasp at both ends and bend at middle joint until tip breaks off - then follow our easy installation instructions above.

LOXIN EXPANSION SHIELDS

Cat. No. 3600
SIZE RANGE: 1/4" to 3/4"

- * Use in concrete, brick, or stone
- * Shield expands as bolt is tightened
- * GSA: FFS-325, Group 2, Type 2, Class 2, Style 1



Drill hole and install Loxin flush with surface of hole. Position fixture, insert bolt into Loxin and tighten.

DRILL AND TAP SCREWS

Cat. No. 1700 (Bulk)
Cat. No. 1900 (Packaged)
SIZE RANGE: 6-32 x 3/8" to 1/4-14 x 1 1/2"

- * Self-drilling through steel in one operation
- * Saves time and labor
- * Two point lengths - #2 and #3
- * Nine head styles available in various lengths:

Phillips Pan
Phillips Oval
Phillips Round Washer
Hex Washer Slotted
Hex Washer
Bonded Sealing
Hex Washer
Phillips Bugle
Phillips Wafer
Square Socket Pan

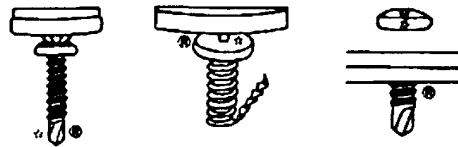

BLIND RIVETS

Cat. No. 2300
SIZE RANGE: 1/8" Dia. to 3/16" Dia.
.020 Grip to .625 Grip

- * Ideal for limited space applications
- * Installation tool required
- * Can be used to join materials of various thicknesses
- * Available in steel and aluminum

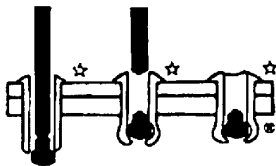

Drill recommended size hole. Insert rivet in installation tool until the rivet head is flush with the nose piece. Insert rivet into hole in material to be fastened. Squeeze handle of tool until mandrel breaks and fastening is complete.

CONTRACTOR'S BLIND RIVET TOOLS

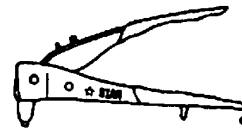

**Concrete
Scru 'N' Tap™**
Fastening System



3/16" x 3-1/4" Hex Phillips Slot

Grip Range 1-3/4" - 2-1/4"

Drill 5/32" x 3-1/2" Hole

100 Screws & Drill Bit



**Concrete
Scru 'N' Tap™**
Fastening System



1/4" x 3-3/4" Hex Phillips Slot

Grip Range 2-1/4" - 2-3/4"

Drill 3/16" x 4" Hole

100 Screws & Drill Bit

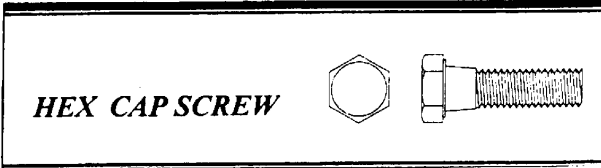

HEX CAP SCREW



HEAVY HEX NUT

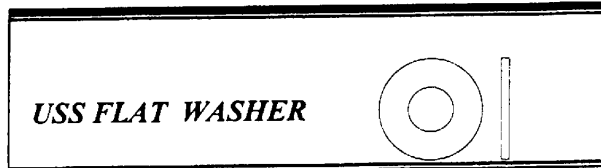

USS FLAT WASHER



*REGULAR SPLIT
LOCK WASHER*

STOCK SIZES RANGE FROM 1/4" TO 1 1/4"

METRIC SIZES ARE ALSO AVAILABLE.

**BAND-IT®
Band, Buckles
and Tools**

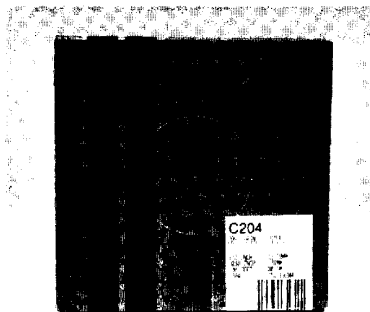

BAND-IT Band



BAND-IT Buckles

Ear-Lokt Buckles in Type 201 stainless steel are designed to accommodate both single and double wrap clamps. The unique teeth and ears provide for maximum clamping strength.



The BAND-IT Tool

SAMSEL#
MSC 1093

**BAND-IT Band
BAND-IT Buckles
The BAND-IT Tool
Tension Limiter**

BAND-IT Band in Type 201 stainless steel has been the industry standard for over 54 years. Type 201 stainless steel has superior yield and tensile strength properties to provide maximum clamping strength. All BAND-IT sizes feature fully rounded smooth edges for safety and easy installation. For clamps of even greater strength, use a double wrap, threading the Ear-Lokt Buckle each time around.

BAND-IT Band
100 Ft. Per Roll (30.5M)

Type 201 Stainless Steel							
Cat. No.	UIC No.	Width Inches	mm	Thickness Inches	mm	Weight Lbs	Kg
C202	13202	¼	6.35	.020	.51	1.7	.9
C203	13203	⅜	9.53	.025	.63	3.2	1.6
C204	13204	½	12.70	.030	.76	5.1	2.4
C205	13205	⅝	15.88	.030	.76	6.4	3.0
C206	13206	¾	19.05	.030	.76	7.7	3.6

Available in mill coil lengths.

SAMSEL#
MSC 944 - 3/8" MSC 940 - 1/2"
MSC 946 - 5/8" MSC 942 - 3/4"

BAND-IT Buckles
Package Quantity — 100

Type 201 Stainless Steel					
Cat. No.	UIC No.	Width Inches	mm	Weight Lbs	Kg
C252*	13252	¼	6.35	.3	.1
C253	13253	⅜	9.53	.8	.4
C254	13254	½	12.70	2.1	1.0
C255	13255	⅝	15.88	2.4	1.1
C256	13256	¾	19.05	3.7	1.7

*Free-End clip design. See page 9.

SAMSEL#
MSC 950 - 3/8" MSC 948 - 1/2"
MSC 952 - 5/8" MSC 1572 - 3/4"

BAND-IT Tool

A drop forged tool with tensioning capability of over 2,400 lbs. and a built-in cutter. New, improved features include: • A spring loaded gripper lever for improved band tensioning • A friction held cutoff lever with plastic grip for easier operation • Permanent lubrication on the tension screw to extend tool life and speed clamping • A zinc plated black chromate finish to provide superior corrosion resistance • A spin handle retaining ring to keep parts intact. The BAND-IT Tool is used to apply BAND-IT Bands and Buckles, strapping and Free-End clamps. See instructions on page 44.

The BAND-IT Tool

Cat. No.	UIC No.	Description
C001	13001	The BAND-IT Tool Pkg Qty 1 Weight 4.4 Lbs 2.0 Kg
C043	13043	Close Quarter Tension Nut Replaces tool tension handle when space is limited. Pkg Qty 1
C006	13006	Tension Screw/Handle Kit Pkg Qty 1

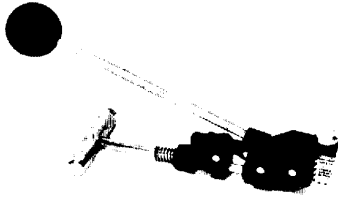

Center Punch Tool — T300

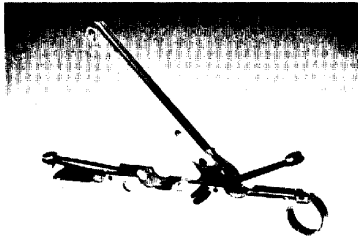

Center Punch Tool — S38

SAMSEL#
MSC 1338

Center Punch Tools

These ratchet action tensioning tools are for applying Center Punch and Center Punch Open-End clamps with a center punch lock. See page 49 for instructions.

Center Punch Tools

Cat. No.	UIC No.	Description	Weight		Pkg Qty
			Lbs	Kg	
T300	34300	For 3/8" (15.88mm) Wide Clamps	3.15	1.5	1
T301	34301	For 3/8" (9.53mm) Wide Clamps	3.15	1.5	1
S032	30032	3/8" Adapter Insert for T300 Tool	.02	.01	1
T256	34256	Mallet (Forged Steel)	2.05	.9	1
S038	30038	For 3/8" (9.53mm) and 5/8" (15.88mm) Wide Clamps	1.10	.5	1

Replacement Parts

T251	34251	Center Punch Head for T300 & T301			1
T252	34252	Center Punch Holder for T300 & T301			1
S190	30190	Punch for T300 & T301			1
S202	30202	Replacement Punch Assembly for S38			1
J038	20038	Winding Mandrel Assembly			1



TIGHTENING TOOLS

SAMSEL #
FAB 094 MK5 - F/T18-T50
FAB 095 F/T 150

HEAVY DUTY LASHING CABLE TIES

Samsel P/N	Length	Min. Tensile Unlocking Strength
FAB 060	8 7/8"	120 lbs
FAB 063	11 7/8"	120 lbs
FAB 068	15 1/4"	120 lbs.
FAB 069	15 1/4"	120 lbs. black

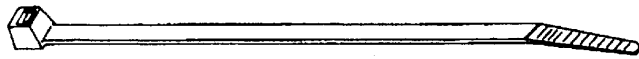

**WE HAVE THOUSANDS OF ITEMS IN STOCK.
CALL US TODAY.**



HOUSEHOLD STAPLE GUN TACKER

**No. T-55 All Purpose
STAPLE GUN TACKER**

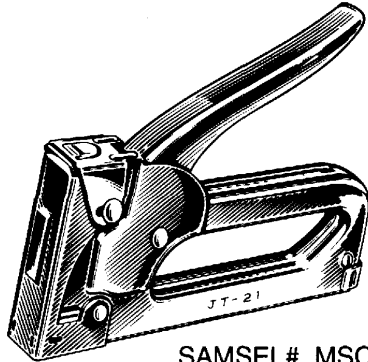

SAMSEL# MSC 1528



SAMSEL# MSC 1529

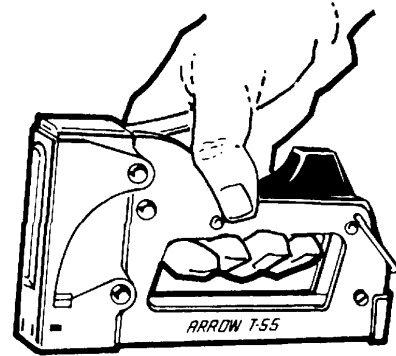

SAMSEL# MSC 325

**PROFESSIONAL
GRADE ELECTRIC
STAPLE GUN**

ELECTRIC STAPLE GUN

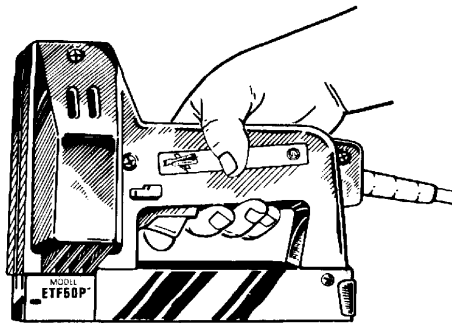

SAMSEL# MSC 1812

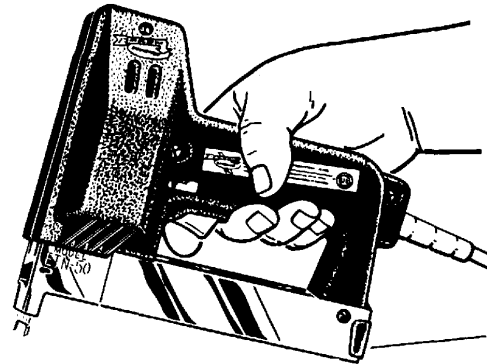

SAMSEL# MSC 1333



FLUSH FRONT - EXTENDED NOSE



No. T-50 Heavy Duty STAPLE GUN TACKER

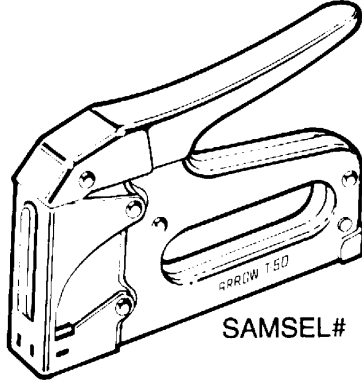

SAMSEL# MSC 439

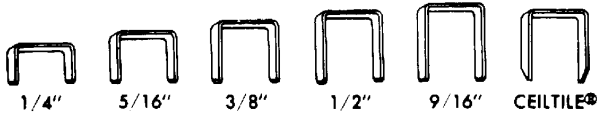

MSC 307 MSC 802 MSC 800 MSC 309 MSC 1293 MSC 311

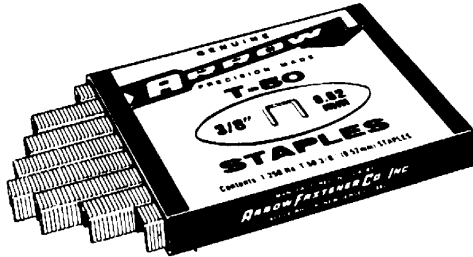

No. HT-50A Heavy Duty HAMMER TACKER

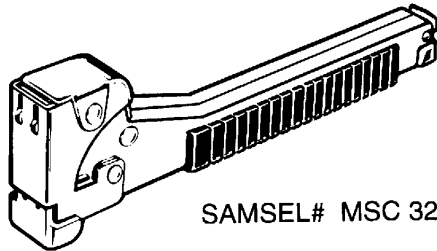

SAMSEL# MSC 323



Multi-Purpose STAPLE GUN TACKER KIT

KIT CONTAINS

- No. T-50 Heavy Duty STAPLE GUN TACKER
- No. T-50 Screen / Piggyback Attachment
- No. T-50 Wire Attachment
- No. T-50 Window Shade Attachment
- No. SL-50 Staple Lifter
- Box of 1250 #T-50 Staples — 1/4" Leg

with Sturdy Blow-Molded Storage Case

SAMSEL# MSC 1752

Sheathed Cable STAPLE GUN TACKER

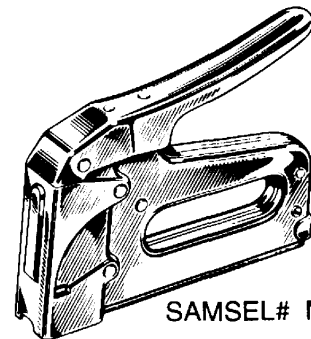

SAMSEL# MSC 18

INSULATED WIRE/CABLE STAPLER
 SAMSEL# MSC 1817 - 1/4"
 MSC 1818 - 5/16"



KLEENSEAL®

lubricating equipment & accessories

HEAVY DUTY LEVER GUNS Rugged/Dependable/Jam Proof

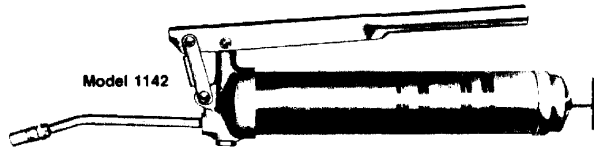

Model 1142 First choice by all users. Holds 16 ounces. Heavy duty, high-pressure grease gun. Reloads three ways. Delivers all pressure gun lubricants in coldest weather.

SAMSEL#
MSC 653 1142

1/8" - 90° FITTING - 10 PACK
SAMSEL#
LUB 801 5490

REPLACEMENT COUPLERS

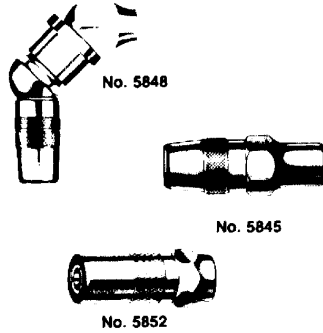

No. 5848 360° hydr. coupler adapter. Swivels in full circle. Has eight locking positions.
No. 5845 Coupler for contacting hydr. fittings. Reversible coupler jaws double service life.
No. 5852 Small diameter hydr. coupler. For use with hand guns only.

SAMSEL#
LUB 016 5845
LUB 026 5852

FILLER NIPPLE



No. 91108 Filler nipple for converting old hand guns to a modern way of loading. Includes ball check; 1/8" N.P.T. male thread.

SAMSEL#
LUB 166 91108

NOZZLE EXTENSIONS

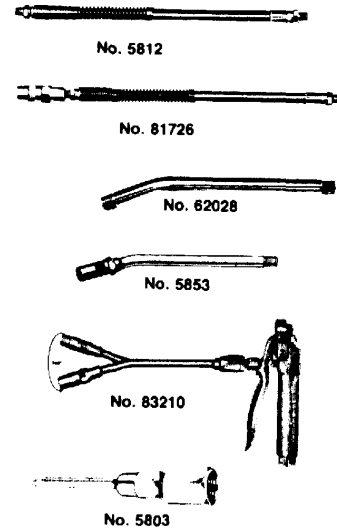

FLEXIBLE SPRING GRIP

No. 5812 Whip hose ext. with 12" center.
No. 5818 Whip hose ext. with 18" center.
No. 71512 Hand gun whip hose ext. with 12" center.
No. 71518 Hand gun whip hose ext. with 18" center.

HYDR. COUPLER EXT. ADAPTER

No. 81795 Includes 5845 coupler; 8" hose with locking sleeve.

FLEXIBLE & RIGID EXT. ADAPTER

No. 5858 Flexible or rigid adapter fits any control valve or hand gun. Metal sleeve locks action.

WHIP HOSE ASSEMBLIES

No. 81726 12" lgth. with 5845 coupler.
No. 81725 18" lgth. with 5845 coupler.
No. 3034 12" lgth. with 81458 coupler.

RIGID EXTENSIONS

No. 62026 6" seamless steel ext. tube.
No. 62061 12" seamless steel ext. tube.
No. 62117 18" seamless steel ext. tube.

SAMSEL#

LUB 036 81726
LUB 041 5812
LUB 046 5818
LUB 186 62061

Geocel®

TECHNICAL DATA

EXPANDING FOAM SEALANT

1. PRODUCT NAME

Geocel Expanding Foam Sealant.

One component polyurethane foam sealant in a pressurized container.

2. MANUFACTURER:

GEOCEL CORPORATION
P.O. Box 398
Elkhart, IN 46515
Phone: (800) 348-7615
Fax: (219) 264-3698

3. PRODUCT DESCRIPTION:

Geocel Expanding Foam Sealant is a single component polyurethane foam designed to fill gaps, cracks, etc. and used to stop air infiltration around door and window frames and pipe penetrations.

COMPOSITION AND MATERIALS

Geocel Expanding Foam Sealant is a isocyanate/polyol prepolymer foam. Ingredients include surfactants for emulsion stabilization, a fire retardant and a catalyst.

PACKAGING:

12 oz. and 20 oz. can

4. TECHNICAL DATA

(See chart on page 2.)

4. INSTALLATION

Surface preparation – All surfaces to be foamed should be clean, free of dust, dirt, oil or similar materials.

APPLICATION: Expanding Foam Sealant should be applied in well ventilated area, or with respiratory protection.

For best results, use Expanding Foam Sealant with sufficient atmospheric humidity. Deep, dry, cavities may need to be moistened before application. However, too much wetness will interfere with adhesion. Fill the lowest part of the cavity first. When using Expanding Foam, fill



only 35% with foam since expanding formula expands approximately 3 times. Temperature of the surface to be foamed should be 23° F. to 95° F. (-5° C. to 35° C). Optimal can temperature is 70° F. to 80° F. (21° C. to 27° C.). Geocel Expanding Foam Sealant will withstand continuous temperatures up to 240° F. (115° C.)

Do not disturb freshly dispensed foam because it will collapse. Expanding Foam Sealant will be tack free in 20 minutes and cures to firm resiliency within 8 hours.

YIELD: 3/8" bead 250 ft., 1/2" bead 150 lineal foot

12 oz. can yield = 0.33 cu. ft.

20 oz. can yield = 0.55 cu. ft.

For optimum yield apply between 60° F to 95° F. (16° C to 35° C).

PAINTING: Expanding Foam Sealant may be painted or stained after full cure. NOTE: Outdoor applications must be coated with a paint or stain to protect foam from ultra-violet light exposure.

CLEANING: Uncured foam can be cleaned up with acetone, nail polish remover, or paint thinner. Clean up after each use. See application sheet for further cleaning and reuse instructions.

STORAGE LIFE: One year. Do not store Expanding Foam Sealant above 120° F. (49° C.). Storage temperature should be between 30° F. to 80° F. (15° C. to 27° C).

WARNING: CONTAINS FLAMMABLE GAS. CONTENTS UNDER PRESSURE. CAN MAY BURST IF LEFT IN A CLOSED AREA SUCH AS A MOTOR VEHICLE. KEEP AWAY FROM HEAT, SPARKS AND OPEN FLAME. May cause respiratory tract and skin irritation. The foam produced is combustible and may present a fire hazard if exposed to flame or temperature above 240°F. (116°C). **DO NOT** puncture or incinerate. **KEEP OUT OF REACH OF CHILDREN.** Avoid contact with skin and eyes. Use only with adequate ventilation. Store in a cool, dry place below 120°F. (49°F).

Follow manufacturer's precautions when handling solvents.

PRECAUTIONS: Solvents might be damaging to paints and painted metal siding. Make sure that the intended application of this product conforms with all local codes. Cans are pressurized and must not be punctured or incinerated.

6. AVAILABILITY AND COST:

Geocel Expanding Foam Sealant is available from distributors throughout the United States. Information and further technical data are available from your local Geocel representative or from Geocel's corporate office.

SAMSEL #
CHM 565 20 OZ.

Geocel®
2000
CONSTRUCTION
CAULKING SEALANT



- SAMSEL #
- CHM 560 11 OZ. CLEAR
 - CHM 561 11 OZ. WHITE
 - CHM 562 11 OZ. BRONZE
 - CHM 563 11 OZ. GREY

Geocel®

Geocel®
2300®
CONSTRUCTION
TRIPOLYMER SEALANT

Geocel 2300® is designed to combine the flexibility of urethanes, the paintability of acrylics, the long life expectancy of silicones, and superior adhesion to virtually any material.

Check these product benefits:

- Asphalt Compatible
- Adheres to Wet or Oily Surfaces
- Mildew Proof
- Paintable
- Stays Flexible - Will Not Crack
- No Dirt Pick-Up
- Exceptional Adhesion to Vinyl
- Superior Ultraviolet Resistance
- Applies at Any Temperature
- Available in Ten Popular Colors and Crystal Clear
- Resealable
- Easy to Apply and Clean Up



Geocel®

2010
BRUSHABLE SEALANT



- SAMSEL #
- CHM 564 1 QT.



**ELMER'S REDI-SPACK LITE™
WALL REPAIR COMPOUND**

Quick, easy work-saver.
Ready-to-use spackling comes in convenient, resealable can. Easy to spread, easy to sand, holds paint well. Durable formula dries fast, resists shrinking, sagging and cracking. Patches drywall and plaster. Recommended for small to medium size repairs on walls and ceilings in apartments, homes and offices. Cleans up with water. *Non-flammable,* non-toxic,* no harmful fumes.**

STOCK NO.	CASE U.P.C.	DESCRIPTION	STANDARD PACK	
			INNER	CASE
E-826	00826	½ Pint Can	—	12
E-827	00827	Pint Can	—	6
E-828	00828	Quart Can	—	6

SAMSEL#
CHM 607 - 6 oz.

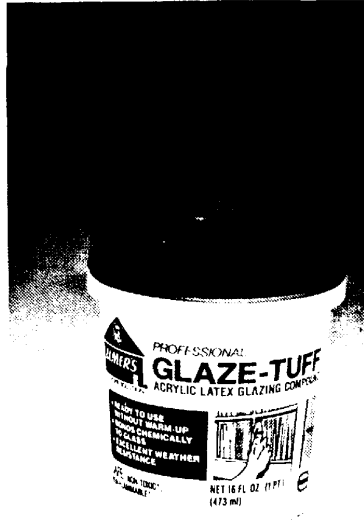

**ELMER'S GLAZE-TUFF™
PROFESSIONAL GLAZING
COMPOUND**

Bonds chemically with glass.
Acrylic latex formulation. Easy to apply with a putty knife from can without warmup. Bonds chemically with glass, adheres to wood, metal, plastic, even damp surfaces. Strong bond stays flexible, resists drying out, cracking, peeling. Can be painted 30 minutes after application... won't soften or discolor paint. Water clean-up. *Non-flammable,* non-toxic,* no harmful fumes.**

STOCK NO.	CASE U.P.C.	DESCRIPTION	STANDARD PACK	
			INNER	CASE
E-880	00880	½ Pint Can	—	12
E-881	00881	Pint Can	—	6
E-882	00882	Quart Can	—	6
E-884	00884	Cartridge (10.5 oz.)	—	10

SAMSEL#
CHM 623 - 1/2 pt.



**ELMER'S MULTI-PURPOSE
FLOORING ADHESIVE—LATEX**

Makes the job easier for pros and homeowners.
Installs a wide variety of floor coverings indoors... including vinyl, vinyl-asbestos, asphalt and rubber tile, linoleum, indoor carpet, jute, foam and sponge rubber backed carpets. Can be used with plywood, hardboard, asphalt-impregnated felt and concrete floors... on, above or below ground level. Light color, almost odorless, resists moisture, freeze/thaw stable. Cleans easily from hands, tools, work area with water. *Non-flammable,* non-toxic.**

STOCK NO.	CASE U.P.C.	DESCRIPTION	STANDARD PACK	
			INNER	CASE
E-857	00857	Quart Can	—	6
E-858	00858	Gallon Can	—	2
E-854	00854	5 Gallon Pail	—	Each

SAMSEL#
CHM 626 - 1 gal.



ELMER'S RUBBER CEMENT

The choice for paper projects.
Clean, non-wrinkling adhesive for paper projects such as paste-up, mounting photos and sketches. Resists curling, shrinking, staining. Dries to strong, almost colorless bond. No mess — excess rubs off with finger when dry.

STOCK NO.	CASE U.P.C.	DESCRIPTION	STANDARD PACK	
			INNER	CASE
E-904	00904	4.1 fl. oz. Bottle	—	12

SAMSEL#
CHM 620



ELMER'S PROFESSIONAL CARPENTER'S WOOD GLUE

Specifically formulated for wood.
Grabs fast but allows repositioning; reduces clamping time. Penetrates wood deeply for strong bond. Can be painted. Will not gum up from heat when sanded or sawed. Easy water clean-up. Non-flammable,* non-toxic,* no harmful fumes.*

STOCK NO.	CASE U.P.C.	DESCRIPTION	STANDARD PACK	
			INNER	CASE
E-700	00700	4 fl. oz. Bottle	12	48
E-701	00701	8 fl. oz. Bottle	6	24
E-702	00702	16 fl. oz. Bottle	6	24
E-704	00704	Quart Bottle	—	6
E-705	00705	Gallon Bottle	—	2
E-706	00706	5 Gallon Pail	—	Each
E-970	00970	50 Gallon Drum	—	Each

SAMSEL#
MRN 118 - 1 GAL.
MRN 119 - 16 OZ.

SAMSEL#
CHM 610 - WONDER BOND GLUE

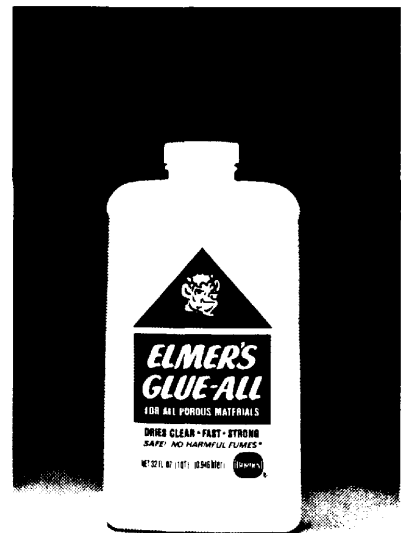

ELMER'S GLUE-ALL™

America's favorite household glue.
Strong and versatile, Elmer's Glue-All sets fast, dries to a clear, lasting bond. Ideal for wood, paper, cloth — all porous materials. Easy water clean-up. Shatter-resistant plastic squeeze bottle. Non-flammable,* non-toxic,* no harmful fumes.*

STOCK NO.	CASE U.P.C.	DESCRIPTION	STANDARD PACK	
			INNER	CASE
E-375	00375	1 1/4 fl. oz. Bottle	12	48
E-372	00372	4 fl. oz. Bottle	12	48
E-379	00379	8 fl. oz. Bottle	6	24
E-371	00371	16 fl. oz. Bottle	6	24
E-384	00384	Quart Bottle	—	6
E-395	00395	Gallon Bottle	—	2
E-393	00393	5 Gallon Pail	—	Each
E-960	00960	50 Gallon Drum	—	Each

SAMSEL #
MRN 121 - 16 oz.



ELMER'S SILICONIZED ACRYLIC LATEX CAULK

Superior general purpose indoor/outdoor caulk.

Easy to use siliconized formula provides maximum adhesion and resistance to moisture, mildew, cold and dust. Adheres to dissimilar building materials with ease . . . aluminum, cement, brick, plaster, wood, stucco. Tightly seals cracks and openings around windows, doors, flashings, masonry, chimneys. Paintable 30 min. after application under normal conditions. 20 year warranty. Non-flammable,* non-toxic.*

STOCK NO.	CASE U.P.C.	DESCRIPTION	STANDARD PACK	
			INNER	CASE
E-930	00930	(White) 10.8 fl. oz. Cartridge	—	10
E-935	00935	(Clear) 10.5 fl. oz. Cartridge	—	10

SAMSEL#
CHM 041 - CLEAR
CHM 043 - WHITE

ELMER'S SILICONE RUBBER SEALERS—WHITE & CLEAR

Permanently flexible seal.

Versatile, tough, long-lasting. Silicone Rubber Sealers insulate and waterproof over a wide range of temperatures. Consistently outperform other popular silicones in elongation, tensile, tear and peel strength. Use wherever you need your best protection; excellent for bath and shower. White sealer offers extra mildew control. Bonds porcelain, ceramic, glass, marble, fiberglass, painted surfaces, most metals, non-oily woods, many plastics and rubbers. Conforms to Federal Specifications TT-S-001543A and TT-S-00230C(2) ASTM C-920-79 Type S, Grade N.S., Use N.T. 20 year warranty.

STOCK NO.	CASE U.P.C.	DESCRIPTION	STANDARD PACK	
			INNER	CASE
E-910	00910	(Clear) 10.3 fl. oz. Cartridge	—	10
E-911	00911	(White) 10.3 fl. oz. Cartridge	—	10

SAMSEL #
CHM 612 - CLEAR 10.8 oz.
CHM 613 - WHITE 10.8 oz.



ELMER'S DRYWALL & PANEL ADHESIVE

Many purpose, multi-material bonding.
 All you need to bond hardwood/plywood panels, hardboard wall panels, gypsum board, drywall . . . plus brick veneer directly to wood studs, plaster, cinderblock, cement, concrete block and other wall surfaces. Strong, durable. Grips fast. Allows repositioning. Quick water clean-up. Safe, non-flammable,* non-toxic.*

STOCK NO.	CASE U.P.C.	DESCRIPTION	STANDARD PACK	
			INNER	CASE
E-801	00801	10.8 fl. oz. Cartridge	—	10

SAMSEL#
 CHM 609



ELMER'S SUBFLOOR & CONSTRUCTION ADHESIVE

No solvent fumes, easy water clean-up.
 Bonds plywood to wood subfloors . . . also bonds under-layment, composition panels, wood panels, rigid foam panels, drywall, trim, stairtreads, and other construction materials. Excellent bond strength on dry, wet or frozen lumber. Flexible, bridges gaps. Resists environmental aging, oxidation, moisture and stress movement of bonded surfaces. Conforms to A.P.A. specifications AFG-01.

STOCK NO.	CASE U.P.C.	DESCRIPTION	STANDARD PACK	
			INNER	CASE
E-813	00813	10.8 fl. oz. Cartridge	—	10

SAMSEL#
 CHM 608 - 10.8 oz.

ELMER'S PANEL & FOAM ADHESIVE

Why use 2 adhesives — one will do.
 One cartridge in one gun bonds polyurethane or polystyrene foam insulation sheets in place, then adheres paneling material. Strong, water-resistant, and resilient . . . won't become brittle with age. Saves time changing cartridges and guns. Cleans up fast with water. Low odor. Safe, non-flammable,* non-toxic.*

STOCK NO.	CASE U.P.C.	DESCRIPTION	STANDARD PACK	
			INNER	CASE
E-800	00800	10.8 fl. oz. Cartridge	—	10

SAMSEL#
 CHM 615



ELMER'S ACRYLIC LATEX CONCRETE CRACK SEALER

Repairs damaged driveways, sidewalks and patios.
 Forms a chemical bond with concrete, providing a tough, flexible seal that cures overnight. Easy application in standard caulking gun, even to damp surfaces. Paintable. Resists moisture and weather. Easy clean-up. Non-flammable,* non-toxic,* no harmful fumes.* White only.

STOCK NO.	CASE U.P.C.	DESCRIPTION	STANDARD PACK	
			INNER	CASE
E-807	00807	10.8 fl. oz. Cartridge	—	10

SAMSEL#
 CHM 603

ARROW
ELECTRO-MATIC
HOT
MELT
GLUE GUNS

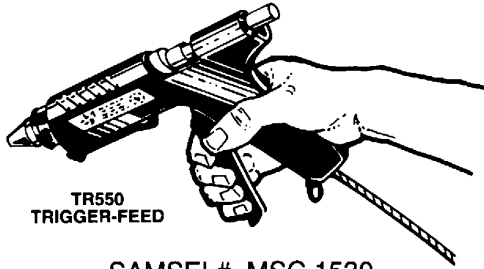

TR550
TRIGGER-FEED

SAMSEL# MSC 1530

**HOT MELT
GLUE STIX**

TYPES OF HOT MELT AVAILABLE

ALL-PURPOSE CLEAR*

FOR CRAFTS, HOBBIES AND GENERAL REPAIRS

For woodworking, ceramics, leather, canvas, fabrics, cardboard, plastics, metal, etc. Press surfaces together within 15 seconds. Sets in 30 to 60 seconds.

**WHITE CAULK/SEALER/GLUE
FOR CAULKING AND SEALING**

For windows, walls, tubs, boats, etc. Sets in 30 to 60 seconds. When used as glue, refer to above. *

SLOW SET

ALLOWS MORE TIME FOR LINEUP ON LARGER AREAS

On wood, metal, plastics, leather, fabrics, etc. Sets in 90 to 120 sec.

**REMOVABLE 8" ALL PURPOSE CLEAR
FOR WEATHERSTRIPPING**

For windows and walls to seal out drafts in winter, easily removed in summer.

SAFETY PRECAUTIONS

Wear safety glasses. Do not touch heated nozzle area of glue gun or hot glue. Do not allow heated nozzle area to lie in contact with working surface. Unplug when not in use.

GLUE STICKS

4" - 6 per carton

SAMSEL# MSC 1531

10" - 12 per carton

SAMSEL# MSC 1813

REMINDER

Any tool NOT used with caution can cause injury.

ALWAYS THINK SAFETY!