



**E-440 - 84  
Heavy Duty Two Speed  
Power Cable Puller**

**8,000 POUNDS MAXIMUM PULLING POWER**

- Puller Packages and many other accessories are available for pulling cable.
- Welded Steel frame
- Built-in Read-Out Meter tells pull force and amps at all times and keeps operator informed when cable puller is reaching overload conditions.
- Anti-Backlash (clutch) Bearings allows capstan to rotate in only one direction.
- Ratchet Safety Dog provides positive holding of the capstan during temporary shut down.
- Tapered Capstan allows operator to release more easily rope tension, providing more operator control during pull
- Fast Set-Up adjustable vise chain with hand screws quickly anchors the power unit to beams, pipe, or conduit, or to the E-849 Pipe Adapter Sheave. No wrenches or special tools required

POWER REQUIREMENT: 115V AC, 1-1/2 HP Heavy Duty Electric Motor  
(also available in 230V call for details)

TWO SPEED ( FT. PER MINUTE ): 14 FPM Heavy Pulls  
55 FPM Lighter Pulls

WEIGHT: 72 lbs.

DIMENSIONS: 21-1/2"L x 15-1/2"W x 14-1/2"H

**SAFETY NOTE: Make sure all pulling accessories have the proper load rating for the puller and pull. Read and understand both the operating and safety instructions before pulling cable.**

SAMSEL #  
PUL 005

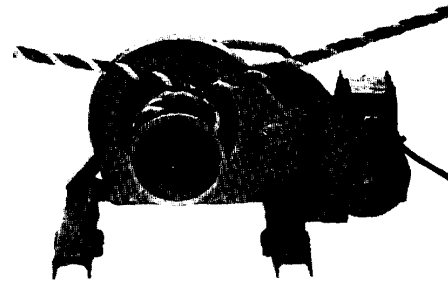

LOW SPEED-8000 LBS. MAXIMUM PULL

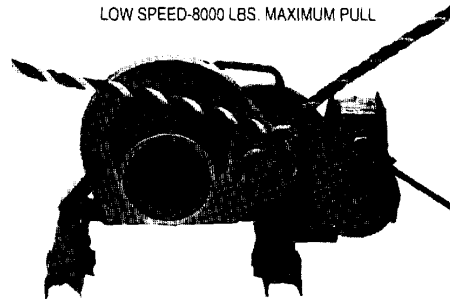

HIGH SPEED-2000 LBS. MAXIMUM PULL

**E-200 Metal  
Stud Punch**

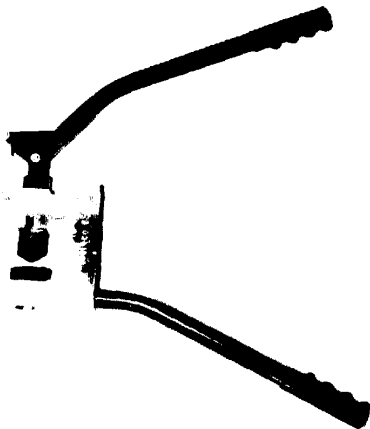

**PUNCHES UP TO 20 GAUGE MILD STEEL  
IN ONE SINGLE STROKE**

- Punches 1-11/32" dia. holes for 1" Conduit
- Optional punches and dies for 1-1/8" dia. holes ( 3/4" Conduit )
- Punches "H" studs without damaging flanges
- Automatic Built-in Stripper eliminates punch hang-ups
- Cannot be used for punching stainless steel
- Weight, 6 lbs.

STANDARD EQUIPMENT		OPTIONAL EQUIPMENT	
CAT. #	DESCRIPTION	CAT. #	DESCRIPTION
43-52	1-11/32" Punch (1" conduit)	43-53	1-1/8" Punch (3/4" conduit)
43-95	1-11/32" Die (1" conduit)	43-99	1-1/8" Die (3/4" conduit)

SAMSEL #  
PUN 301



**E-784 ELECTRIC PVC BENDER**

For bending 1/2" - 2" PVC Conduit

- Fast, even heat-up to form up to 90° elbows, offsets, kicks, saddles and concentrics
- Polished reflector surface promotes even heating
- Durable, heavy duty steel construction
- Full length door facilitates loading and unloading
- Lightweight with carrying handle
- Roller Bearings for smooth rotation
- Optional bending template for accuracy

WEIGHT: 15 lbs.  
 POWER REQUIREMENTS: 15 AMPS, 1700 Watts, 115V  
 DIMENSIONS: 28"L x 7"W x 8"H

**Electric PVC Benders 1/2" - 2"**

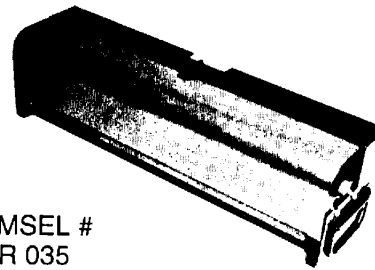

SAMSEL #  
BDR 035

**FOR BENDING 1/2" - 4" PVC CONDUIT**

- Design allows heating of shorter lengths as well as lengths sufficient for 48" radius, 90° bends
- Heats quickly and evenly - reflective surface promotes even heating
- Durable, heavy duty steel construction
- Wheels and handle facilitate mobility

DIMENSIONS : 55"L x 8-1/2"W x 11-3/4"H  
 POWER REQUIREMENTS: 20 AMPS, 2400 Watts, 115 V.

19-E37  
 1/2"-4" Manual PVC Bender w/o plugs

**Electric PVC Benders 1/2" - 4"**

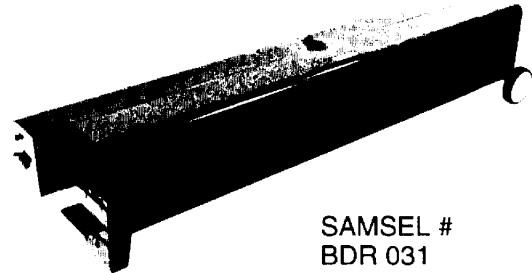

SAMSEL #  
BDR 031

**FOR BENDING 1/2"- 1-1/4" EMT, RIGID/IMC, SHEDULE 40 STEEL PIPE AND ALUMINUM CONDUIT**

- Only two shoes required for bending the entire range of manual bending
- Speed bending of smaller diameter pipe with removable direct handle operation.
- Large 12" diameter wheels for portability on rough terrain.
- Ratchet drive with positive release for larger diameter pipe.
- Easy to read degree indicator allows the operator to determine degree of bend.
- Adjustable stop bar permits the operator to fabricate duplicate stub-ups after measuring only the first piece of pipe.
- Spring loaded brake system applies pressure to bending shoe to prevent the shoe from swinging around while trying to load or unload pipe.
- Can also be purchased individually with one or the other bending shoe.

E-774  
 Combo Mechanical Bender Equipped with 1/2" - 1-1/4" Rigid/IMC Shoe Assembly

97 lbs

**COMBO MECHANICAL BENDER**

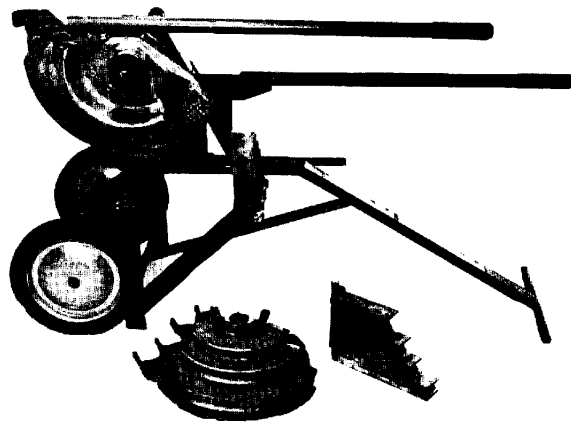

SAMSEL #  
BDR 033

**E-263 Portable Pipe Rack**



SHOWN WITH OPTIONAL CASTERS AND STORAGE BINS.

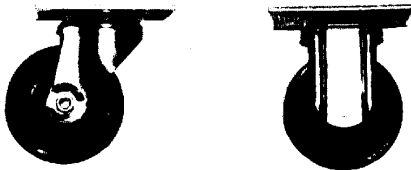

**E-263 PORTABLE PIPE RACKS**

Stores Conduit around bending and threading operations.

- Stores up to 1000 lbs. of pipe on racks
- Use with optional removable bins to store movable materials and small parts
- Optional casters facilitate mobility

Dimensions: 56"L x 34"W x 66"H

Weight: 171 lbs.

**SAMSEL #  
RCK 001**

OPTIONAL STORAGE BINS				
LOCATION	CATALOG NO.	LENGTH	WIDTH	HEIGHT
Upper	E-264	56"	12-1/2"	6"
Middle	E-265	56"	16"	9"
Lower	E-266	56"	13-1/2"	11-1/2"

OPTIONAL CASTERS	
CAT. NO.	DESCRIPTION
E-295	8" Caster Set - 2 Rigid & 2 Swivel with Brake
E-297	8" Caster Set - 2 Rigid & 2 Swivel without Brake

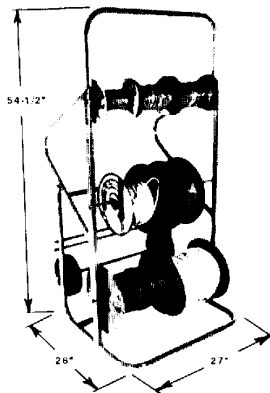

**E-255 MULTI PURPOSE WIRE CART**

- Large capacity wire cart, holds either six 2500' or fifteen 500' spools of wire
- 5/8" OD spindles can easily be removed and stored within frame for larger diameter reels
- The frame is constructed of welded tubular steel for heavy duty use and lighter weight.
- Equipped with sturdy 8" polypropylene wheels.
- Can be used horizontally or vertically.
- Built-in wire guide for horizontal dispensing.
- Weight: 45 lbs.

**SAMSEL #  
PUL 001**



**Wire & Cable Cutter**

**CABLE CUTTERS**

FOR STRANDED COPPER AND ALUMINUM ONLY

- Heat treated alloy steel blades
- Lightweight fiberglass handles with insulated grips

CAT. #	DESCRIPTION	ALUMINUM SIZE	COPPER SIZE	OVERALL LENGTH	WEIGHT
E-320	Hand Cable Cutter	350 MCM.	350 MCM.	22-3/4"	3 lbs.
E-318	Hand Cable Cutter	1000 MCM.	750 MCM.	32"	6 lbs.



E-320

SAMSEL #  
CTR 135

**REPLACEMENT PARTS**

42-036	Replacement Jaws (E-320)
42-033	Replacement Jaws (E-321)
42-041	Replacement Jaws (E-322)

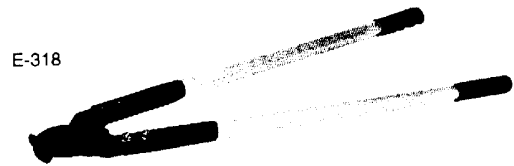

E-318

SAMSEL #  
CTR 137

**CUTS UP TO 750 MCM COPPER AND ALUMINUM CABLE**

- Ratchet action for heavy duty cutting
- Anti-Reversing ratcheting mechanism ensures positive ratchet action
- Release lever allows blade to back out of the cut when necessary
- Hardened alloy steel blades reduce blade breakage
- Blades can be easily sharpened without being removed from tool
- Rubber hand grips make firm grip control possible
- 1-9/16" Jaw Opening
- 15-3/4" Overall Length
- Weight: 30 lbs.

Not recommended for cutting steel or ACSR cable

CAT. #	DESCRIPTION
42-048	Fixed Replacement Blade
42-049	Moveable Replacement Blade

**E-324 Ratcheting Cable Cutter**



SAMSEL #  
CTR 138

**IMPORTANT NOTE:**

The products shown in this catalog are designed and produced for use by a professional operator. Before using any Ensley product make certain that you have read and thoroughly understand that particular tool. Additional copies of instructions may be obtained by writing or calling us with the product catalog number and the serial number of the unit.

The information in this catalog, is accurate to the best of our knowledge, at the time of printing. Ensley reserves the right to make changes in products and product assortments without prior notice.



**PORTABLE  
SPACE HEATERS**

**Propane, Kerosene and Natural Gas Heaters - A size for every need**

**\* Clean Burning \* Safe \* Economical \***

**Forced Air  
Heaters**

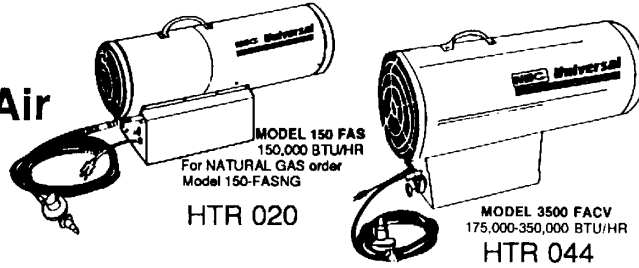

MODEL 150 FAS  
150,000 BTU/HR  
For NATURAL GAS order  
Model 150-FASNG  
HTR 020

MODEL 3500 FACV  
175,000-350,000 BTU/HR  
HTR 044



All Propane Forced Air  
Heaters - AGA Certified

**Infrared  
Radiant  
Heaters**

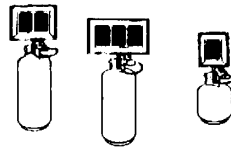

**INFRARED MODELS:**

- 12-IR 11,000 BTU/HR HTR 046
- 24-IR 22,000 BTU/HR HTR 045
- 36-IR 33,000 BTU/HR HTR 047

**Convection  
Heaters**

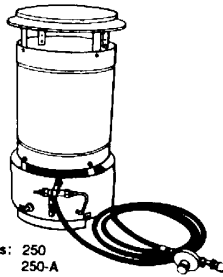

Models: 250  
250-A

HTR 048

**MODELS:**

- 80-V 30,000-80,000 BTU/HR  
AGA CERTIFIED
- 250 750,000-250,000 BTU/HR  
ARL LISTED
- 250-A 75,000-250,000 BTU/HR  
Piezoelectric Ignitor  
ARL LISTED

**Kerosene  
Heaters**

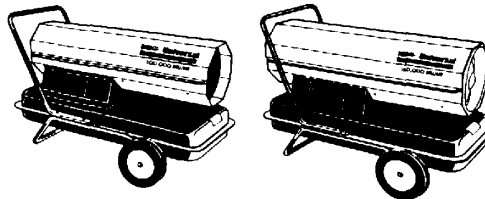

HTR 021

HTR 022

**MODEL**

- K50-FA--50,000 BTU/HR
- K100-FA--100,000 BTU/HR
- K150-FA--150,000 BTU/HR

# OSCILLATING WALL/DESK FAN

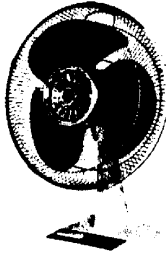

- 3-Speed, 115V, 1 $\phi$ , PSC motor with a 6½' long, 3 conductor cord
- UL Listed / Meets Federal OSHA requirements

Model Number	Type	Blade Size	CFM			Amps (High)	Shipping Weight
			High	Med	Low		
WDF-12	Wall/Desk Fan	12"	1700	1380	930	.5	10 lbs.
WDF-16	Wall/Desk Fan	16"	2100	1700	1150	.8	13 lbs.

SAMSEL#  
FAN 021     WDF-16

# INDUSTRIAL AIR CIRCULATOR — OSCILLATING

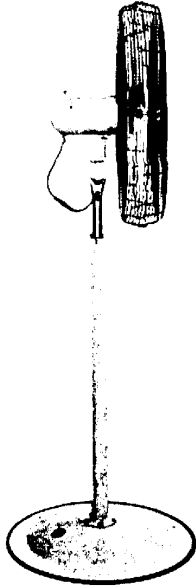

- **Factory assembled motor-blade-guard assembly to simplify final assembly — fan head and mount shipped in one carton**
- 2-Speed, ¼ HP, single phase, 115 volt, totally enclosed permanently lubricated ball bearing motor with pull chain switch
- Fan oscillates in a 90° arc or can be locked in a fixed position
- UL listed
- Meets Federal OSHA standards

Model Number	Type	Blade Size	CFM		Amps (High)	Shipping Weight
			High	Low		
24ACP-O 24ACW-O	Pedestal Wall Mount	24"	5500	4000	2.6	79 lbs. 46 lbs.
30ACP-O 30ACW-O	Pedestal Wall Mount	30"	7000	5200	2.8	82 lbs. 49 lbs.

SAMSEL#  
FAN 001     24ACP-0

SAMSEL#  
FAN 006     30WCP-0

**PATT&N**

# PORTABLE HIGH VELOCITY CIRCULATOR

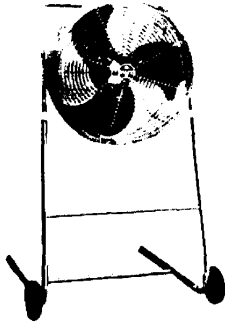

- 3-Speed, permanently lubricated, drip proof, permanent split capacitor motor with 6½' long, 3 conductor cord
- Adjustable tilt stand 33" to 50"
- Chrome plated — All metal construction
- UL Listed / Meets Federal OSHA requirements.

Model Number	Type	Blade Size	CFM @ 2'			Amps	Shipping Weight
			High	Med	Low		
IR-18	Rollaire	18"	4200	2750	2100	3.2	26 lbs.

SAMSEL#  
FAN 026 IR-18

# INDUSTRIAL BENCH/FLOOR CIRCULATOR

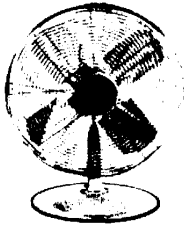

- 2-Speed, ¼ HP, single phase, 115 volt, totally enclosed, ball bearings, permanently lubricated, permanent split capacitor motor
- Oscillating models oscillate in a 90° arc or can be locked in a fixed position
- UL listed / Meets Federal OSHA requirements

Model Number	Type	Blade Size	CFM		RPM		Amps (High)	Shipping Weight
			High	Low	High	Low		
BF 24	Non-Oscillating	24"	5500	4000	1140	1010	2.6	59 lbs.
BF 24-O	Oscillating							64 lbs.

SAMSEL#  
FAN 011 BF24-0

# ECONOMY CIRCULATOR

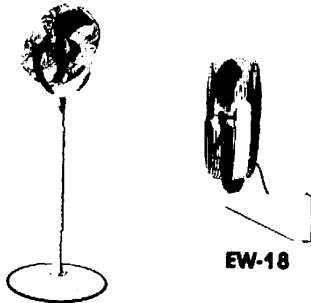

EP-18

EW-18

- 18" Pedestal has a 3-speed, ¼ HP, 115V, 1Ø drip proof motor with a column height of 64".
- UL listed / Meets OSHA requirements.

Model Number	Blade Size	CFM		Amps (High)	Shipping Weight
		High	Low		
EP-18	18"	4200	2100	3.2	62 lbs.
EW-18	18"	4200	2100	3.2	32 lbs.

**PATTAN**

SAMSEL#  
FAN 016 EP-18

**HONDA**  
**Power**  
**Equipment**

Nothing's easier.

Samsel stocks models from 650 to 5000 watts, and will special order any model you want! All models Samsel stocks have "Oil Alert," which means the engine stops if the oil reaches the minimum level. This saves the engine.. and you money!

**GENERATORS**

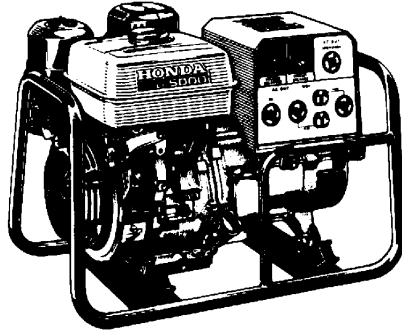

EG5000XK1

- 5000 watts of economical, portable power
- Honda 11hp OHV commercial grade engine
- Electronic ignition
- Automatic voltage regulator
- Oil Alert\*

SAMSEL #  
MSC 1796

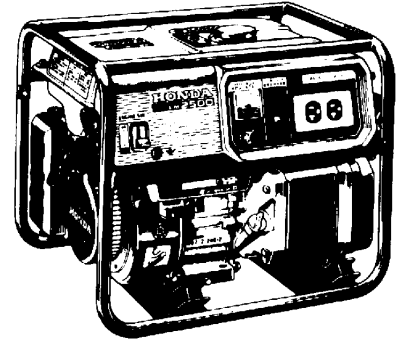

EM2500XK1

- 2500 watts of portable power
- Honda 5.5hp OHV engine
- Simultaneous AC/DC use (auto battery charging)
- Runs 8 hours on a single tank of gas
- Electronic ignition

SAMSEL #  
MSC 1793

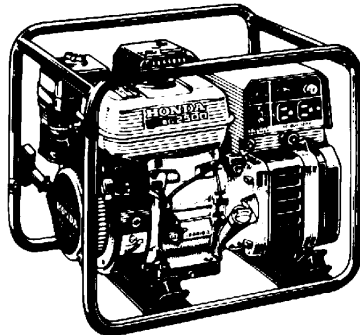

EG2500XK1

- 2500 watts of economical, portable power
- Honda 5.5hp OHV engine
- Simultaneous AC/DC use (auto battery charging)
- Electronic ignition
- Full frame for protection and easy transport

SAMSEL #  
MSC 1792

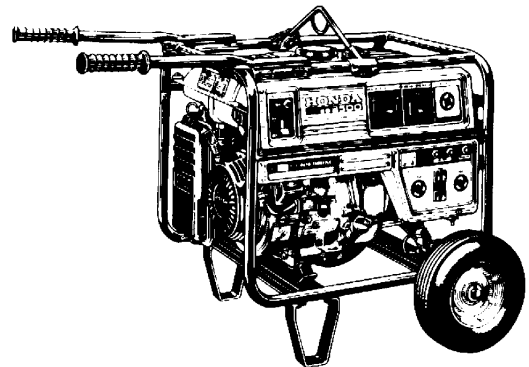

EB3500XK1

- 3500 watts of heavy-duty power
- Honda 8hp OHV commercial grade engine
- Ground fault circuit interrupter
- Fuel meter
- Automatic idle

SAMSEL #  
MSC 1851



**HONDA**  
**Power**  
**Equipment**  
 Nothing's easier.

**WATER PUMPS**

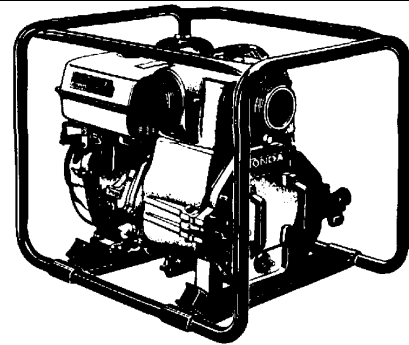

WT20XK2

- Heavy-duty trash pump
- Easy-start Honda 5hp OHV commercial engine
- Oil Alert\*
- 170 gal./min. capacity
- 2" discharge and suction ports
- Centrifugal, self priming

SAMSEL #  
 MSC 1803

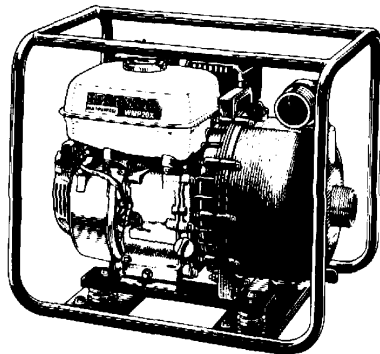

WMP20X

- Honda 5.5hp OHV engine
- 220 gal./min. capacity
- Thermoplastic pump housing
- Variety of water and chemical applications

SAMSEL #  
 MSC 1807

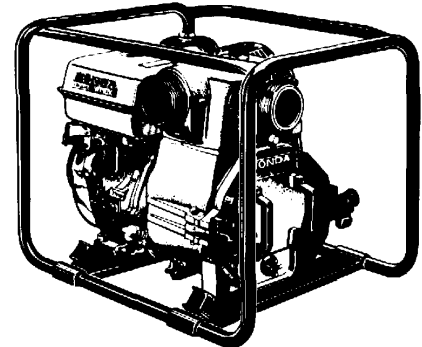

WT30XK2

- Heavy-duty trash pump
- Easy-start Honda 8hp OHV engine
- Oil Alert\*
- 343 gal./min. capacity
- 3" discharge and suction ports
- Centrifugal, self priming

SAMSEL #  
 MSC 1804

The models above are stocked at Samsel. Many other Honda models to pick from. We will special order any model you require. Honda has discharge capacities from 53 to 608 gallons a minute!

**FOR OPTIMUM PERFORMANCE AND SAFETY,  
 WE RECOMMEND THAT YOU READ THE OWNER'S MANUAL  
 BEFORE OPERATING YOUR HONDA POWER EQUIPMENT.**

## Diaphragm Pumps

The power you need to keep on pumping.

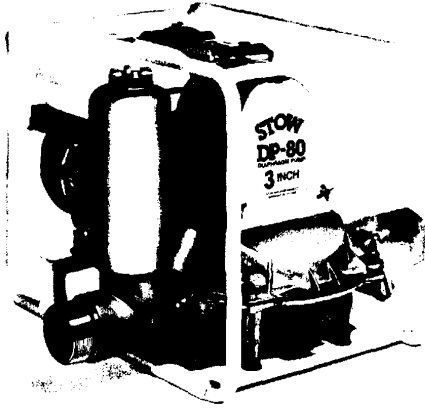

From clear water to heavy sludges and slurries, Stow diaphragm pumps do it all. Ideal for cleaning out cesspools and septic tanks, draining slow seepage from small excavations, trenches and construction sites, or pumping out industrial waste.

Only Stow offers an economical diaphragm pump with all these high performance features standard:

- Heavy-duty, die-cast aluminum body for minimal weight, easy portability and maximum protection.
- Rubber check valves on inlet and discharge prevent clogging.
- Lubricated spur gear provides reliable, lasting performance.
- Automatic oil alert protects engine.
- Durable, machined-steel male nipples resist damage and abuse; provide fast, positive attachment of inlet and discharge hoses.
- Nylon-reinforced natural rubber diaphragms for long-wearing reliability.
- Roll cage protects pump and engine; easy handling too.
- Strainers are standard equipment, not extra-cost options.

MSC 1321 5 HP

## Submersible Pumps

Heavy-duty performance from lightweight equipment.

Stow has the dependable submersible pumps for all your tough jobs. Like sewage disposal, plant effluent pumping, sump pumping, floor draining, condensate removal, even de-watering construction and mining sites where stones and debris are present.

Plus, Stow submersibles are designed for safety and long life under the most severe pumping conditions, and they're priced right too. Here are some of our standard features:

- Cast iron impellers.
- Circumferential water flow system cools motor, prevents overheating and eliminates clogs in soil or sand.
- Abrasion-resistant, double-shaft seals prevent leakage into motor.
- Sealed electrical cable enters through stuffing box for maximum leak prevention.
- Built-in thermal overload protection shuts off motor if overheated. Restarts automatically when temperature drops to normal.
- Rugged steel housing resists dents and internal damage; slim designs for use in small diameter pipe, wells and drains.
- Integral start control eliminates bulky, hazard-prone control box.
- Ball bearing supported shaft assures smooth, vibration-free operation and reduced wear.

Stow submersibles are available in a range of sizes and capacities, from our SS-300 which pumps 10,000 gallons per hour, to our ST-200 Trash Submersible which handles solids up to 5/8" in diameter, to our ultra-compact Yellow Submarine which weighs just 9 lbs. and fits into 6" openings!

MSC 1323 2"

MSC 1345 1"

**STOW**<sup>®</sup>  
Manufacturing Co.

**"ANDREWS" CAM AND GROOVE**

**Type A**  
Male Adapter X  
Female NPT  
MSC 1737 3"  
MSC 1736 2"

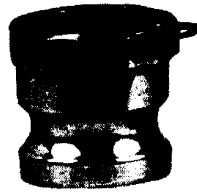

**Type B**  
Female Coupler X Male NPT  
MSC 1732 1-1/2"  
MSC 1738 2"

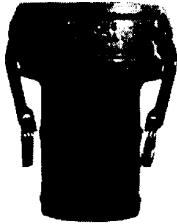
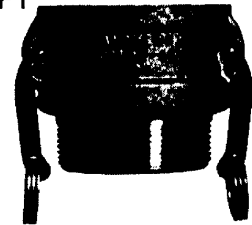

**Type c**  
Female Coupler X  
Hose Shank  
MSC 1433 3"

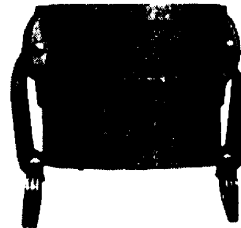

**Type D**  
Female Coupler  
X Female NPT  
MSC 1740 2"  
MSC 1741 3"

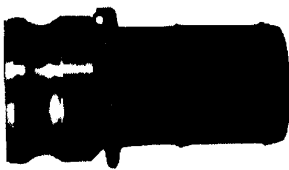

**Type E**  
Male Adapter  
X Hose Shank  
MSC 1432 2"  
MSC 1356 3"

**Rubber Vinyl Garden Hose**  
Super strong dual spiral knit reinforcement  
Rubber/Vinyl formulation maintains strength  
in all weather  
Heavy gauge cover  
Heavy duty, crush proof solid brass cou-  
plings with wrench grips  
MSC 1646 3/4" x 50'  
MSC 1219 5/8" x 50'

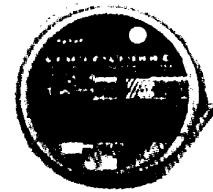

**Thread Sealant**  
CHM 542 1/2 pint can



**SQUELCH, 1 1/2": FOR  
EXTRA-RELIABLE SERV-  
ICE IN STANDPIPE USE.**

Weighs only 11 ounces Shut  
off, straight steam, 160° fog and 170° heat  
shield. NST and IPT. Other threads  
available on special order. Economical yet  
much more durable and heat-resistant  
than plastic nozzles.



**LOCKING TOOL**  
Portable hand tool used to  
apply punch type 3/8" & 5/8"  
band clamps  
MSC 1250

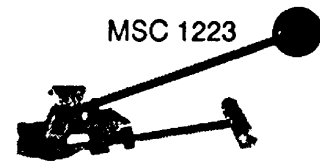

**F100 TOOL**  
For applying 3/8" and  
5/8" band clamps

## V136 Blue Line Layflat Discharge Hose



For general water discharge service. Oil and grease resistant.

- Tube:** Black PVC
- Reinforcement:** Spiraled Textile
- Cover:** Blue PVC
- Recommended Fittings:** Cam & Groove, Short Shank, Quick Disconnect, Combination Nipple, Expansion Ring Type
- Temperature Range:** -10° F to 150° F
- Maximum Length:** 300 foot lengths

### Specifications

I.D.	1½"	2"	2½"	3"	4"	6"	8"	10"	12"
Weight/Foot	.17 lbs.	.23 lbs.	.30 lbs.	.38 lbs.	.59 lbs.	.96 lbs.	1.23 lbs.	2.00 lbs.	2.45 lbs.
Working Pressure (PSI)	75	60	60	50	45	35	35	30	30

*Product should only be used for its original intended purpose. For any other use, proper approvals should be obtained. Refer to Goodall Form #140 for Proper Hose Use, Care, and Maintenance.*

## V130 Elasti-Flex Water Suction Hose



For light duty air, water, sewage, and mild chemicals.

- Tube:** Vinyl
- Reinforcement:** PVC Helix
- Cover:** Green Vinyl (Spec. V131 Clear Vinyl)
- Recommended Fittings:** Cam & Groove, Short Shank
- Temperature Range:** 15° F to 150° F
- Maximum Length:** 100 foot lengths (6" in 40 foot lengths)

### Specifications

I.D.	¾" *	1"	1¼"	1½"	2"	3"	4"	6"	8" *
Approx. O.D.	.94"	1.24"	1.53"	1.78"	2.31"	3.38"	4.43"	6.57"	8.85"
Weight/Foot	.13 lbs.	.23 lbs.	.34 lbs.	.41 lbs.	.58 lbs.	1.08 lbs.	1.62 lbs.	3.03 lbs.	6.10 lbs.
Working Pressure (PSI)	130	106	99	89	79	65	55	47	40
Vacuum (In. Hg)	29	29	29	29	29	29	29	29	20
Bend Radius	3.25"	4.5"	5"	6"	8"	12"	16"	36"	60"

\* Available in V130 Green only

*Product should only be used for its original intended purpose. For any other use, proper approvals should be obtained. Refer to Goodall Form #140 for Proper Hose Use, Care, and Maintenance.*

**L41 Welding Hose  
Single Line Corrugated Type S, Grade R**

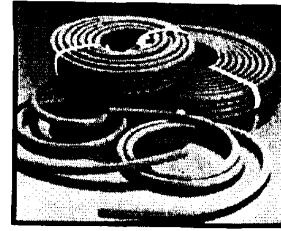

**Tube:** EPDM  
**Reinforcement:** Textile  
**Cover:** EPDM, Red for Acetylene line or Green for Oxygen line  
**Recommended Fittings:** Brass Crimped Male x Female  
**Temperature Range:** -40° F to 180° F  
**Meets RMA/CGA Specifications**

*Specifications*

I.D.	3/16"	1/4"	5/16"	3/8"
Approx. O.D.	7/16"	19/32"	21/32"	23/32"
Weight/Foot	.09 lbs.	.16 lbs.	.19 lbs.	.21 lbs.
Working Pressure (PSI)	200	200	200	200
Bend Radius	1-1/8"	1-1/2"	1-7/8"	2-1/4"

**L42 Tuline Welding Hose  
Type VD, Grade R**

**Tube:** EPDM  
**Reinforcement:** Textile  
**Cover:** Red/Green EPDM  
**Recommended Fittings:** Brass Crimped Male x Female  
**Temperature Range:** -40° F to 180° F  
**Meets RMA/CGA Specifications**

*Specifications*

I.D.	3/16"	1/4"	5/16"	3/8"
Approx. O.D.	7/16"	17/32"	19/32"	21/32"
Weight/Foot	.15 lbs.	.21 lbs.	.25 lbs.	.27 lbs.
Working Pressure (PSI)	200	200	200	200
Bend Radius	1-1/8"	1-1/2"	1-7/8"	2-1/4"

**L43 Tuline Welding Hose  
Type VD, Grade RM**

**Tube:** SBR  
**Reinforcement:** Textile  
**Cover:** Red/Green Neoprene  
**Recommended Fittings:** Brass Crimped Male x Female  
**Temperature Range:** -40° F to 180° F  
**Meets RMA/CGA Specifications**

*Specifications*

I.D.	3/16"	1/4"	5/16"	3/8"
Approx. O.D.	7/16"	17/32"	19/32"	21/32"
Weight/Foot	.17 lbs.	.22 lbs.	.27 lbs.	.30 lbs.
Working Pressure (PSI)	200	200	200	200
Bend Radius	1-1/8"	1-1/2"	1-7/8"	2-1/4"



### F8001 Super Poly Fire Hose III

Fire protection - industrial and municipal. Meets NFPA 1961 (1992 Edition) Standard. F.M. or U.L. Labeled.

- Lining:** EPDM Polymer
- Reinforcement:** 100% Polyester Single Jacket, Hypalon Impregnation Available
- Recommended Fittings:** 1½" - Goodtite hand installed or Expansion Ring  
2" & 2½" - Expansion Ring
- Temperature Range:** 20° F to 150° F
- Maximum Length:** 100 foot lengths

*Specifications*

I.D.	1½"	2"	2½"
Coupling Bowl	1-13/16"	2-3/8"	2-7/8"
Weight/Foot	.22 lbs.	.34 lbs.	.46 lbs.
Test Pressure (PSI)*	300	300	300
Service Pressure (PSI)	150	150	150

\*Performed on new hose

### F20 Seneca Mill Hose



For water discharge service where superior abrasion resistance is required. Used primarily in heavy construction and by rental yards where longer life is required.

- Tube:** EPDM
- Reinforcement:** 100% Polyester
- Cover:** 100% Polyester
- Recommended Fittings:** Cam & Groove, Short Shank
- Maximum Length:** 100 foot lengths (3" and larger - 50 foot lengths)

*Specifications*

I.D.	1"	1½"	2"	2½"	3"	4"
Bowl Size	1-1/4"	1-13/16"	2-3/8"	2-7/8"	3-3/8"	4-3/8"
Weight/Foot	.08 lbs.	.20 lbs.	.32 lbs.	.40 lbs.	.54 lbs.	.82 lbs.
Service Pressure (PSI)	125	125	125	125	125	125
Test Pressure (PSI)	250	250	250	250	250	250

**L15 Viking Jackhammer Hose**

Abrasion and weather resistant cover with excellent adhesions. Rugged yet flexible.

<b>Tube:</b>	Medium Oil Resistant Tube
<b>Reinforcement:</b>	Textile
<b>Cover:</b>	Yellow EPDM
<b>Recommended Fittings:</b>	Universal with one or two bands each end
<b>Temperature Range:</b>	-40° F. to 180° F.
<b>Maximum Length:</b>	50 foot coupled lengths

*Specifications*

I.D.	Approx. O.D.	Weight Per 100 Feet	Working Pressure (PSI)
3/4"	1-5/32"	38.4	300

**L80 Air Hammer Jackhammer Hose**

Economical jackhammer hose. Standard industry cover color.

<b>Tube:</b>	EPDM
<b>Reinforcement:</b>	Textile
<b>Cover:</b>	Red EPDM
<b>Recommended Fittings:</b>	Universal with one or two bands each end
<b>Temperature Range:</b>	-40° F. to 180° F.
<b>Maximum Length:</b>	50 foot coupled lengths

*Specifications*

I.D.	Approx. O.D.	Weight Per 100 Feet	Working Pressure (PSI)
3/4"	1-5/32"	37.3	250

**"AIR KING" Universal Couplings**

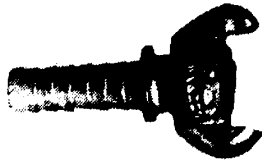

HOSE ENDS

- Malleable Iron  
 MSC129 3/8"  
 MSC 131 1/2"  
 MSC 133 3/4"  
 MSC 135 1"



MALE NPT ENDS

- MSC 1533 1/2"  
 MSC 147 3/4"  
 MSC 1170 1"



FEMALE NPT ENDS

- MSC 1049 1/2"  
 MSC 1169 3/4"  
 MSC 1255 1"



BLANK ENDS

- MSC 1254 AMO



TRIPLE CONNECTIONS

- MSC 1349 AM10

**IF YOU DON'T SEE WHAT  
 YOU NEED  
 CALL US AND ASK.  
 TOLL FREE 1 (800) 892-8012  
 OHIO 1 (800) 892-6781**



Female  
 Spud

Available sizes 1/8 through 6  
 MSC 1050 3/4



MSC 375 Rubber  
 PRT 1289 Neoprene

**WASHERS**

**"AIR CHIEF**

Industrial Quick-Connect Fittings

**1/4" PLUGS**

Male NPT



- MSC 1208 1/4"  
 MSC 1380 3/8"



Female NPT

- MSC 1381 1/4"  
 MSC 1382 3/8"

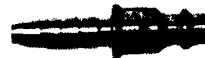

Hose Shank

- MSC 1346 3/8"

**1/4" COUPLERS**



Male NPT

- MSC 1171 3/8"



Female NPT

- MSC 1379 1/4"  
 MSC 1369 3/8"



Hose Shank

- MSC 1662 1/4"  
 MSC 1209 3/8"



**DIXON VALVE & COUPLING**

All BRASS  
including swivel nut  
MSC 1688 1-1/2"



Male NPT Hose Shank  
3500 Steel Nipples

- MSC 1661 1/4" Hose 1/4" NPT
- MSC 1348 3/8" Hose 1/4" NPT
- MSC 1006 3/8" Hose 3/8" NPT
- MSC 1686 1/2" Hose 1/4" NPT
- MSC 1458 1/2" Hose 3/8" NPT
- MSC 1417 1/2" Hose 1/2" NPT

"DIXON" Steel Hose Mender

- MSC 452 3/8"
- MSC 1582 1/2"
- MSC 1386 3/4"
- MSC 451 1-1/2"



**BRASS BARBED HOSE FITTINGS**

MSC 1589  
3/8" Hose 1/2" NPT

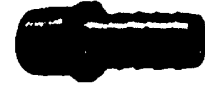

**SELF-HONING AIR VALVES**

Female NPT x Female NPT  
MSC 363 3/4"

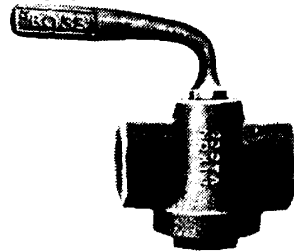

**BRASS BALL VALVES**

Standard Port  
MSC 1051 3/8"  
MSC 1052 1/2"  
MSC 1053 3/4"  
MSC 1054 1"

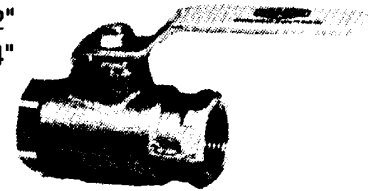

**DIXON WORM GEAR CLAMPS**

STYLE HS CLAMPS



STYLE HSS CLAMPS

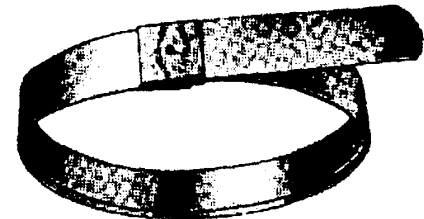

- MSC 1374 3/8"-7/8"
- MSC 1224 7/16"-1"
- MSC 1225 9/16" - 11/16"
- MSC 1238 11/16" 1-1/4"
- MSC 1375 1-1/16" - 1-1/2"
- MSC 1376 3/4" - 1-3/4"
- MSC 1377 1-1/16" - 2"
- MSC 1378 1-5/16" - 2-1/4"
- MSC 1290 1-9/16" - 2-1/2"
- MSC 1226 2-13/16" - 4-3/4"
- MSC 1252 4-1/8" - 5"
- MSC 1239 6-1/8" - 7"

**PUNCH - LOK**

- |         | Width | Dia.   |                     |
|---------|-------|--------|---------------------|
| MSC 051 | 3/8 x | 1-3/16 | MSC 071 5/8 x 3-1/2 |
| MSC 053 | 5/8 x | 1"     | MSC 073 5/8 x 4"    |
| MSC 055 | 5/8 x | 1-1/4  | MSC 093 5/8 x 4-1/2 |
| MSC 057 | 5/8 x | 1-1/2  | MSC 099 5/8 x 5"    |
| MSC 059 | 5/8 x | 1-3/4  | MSC 101 5/8 x 6"    |
| MSC 061 | 5/8 x | 2"     | MSC 1212            |
| MSC 063 | 5/8 x | 2-1/4  | MSC 1131            |
| MSC 065 | 5/8 x | 2-1/2  | MSC 058             |
| MSC 067 | 5/8 x | 2-3/4  | MSC 1197            |
| MSC 069 | 5/8 x | 3"     | MSC 1240            |